

P R O D U C T O V E R V I E W





1	<b>ANTENNA STANDS</b> .....	7
1.1	Product Overview.....	8
1.2	Manual Polarisation (MP).....	10
1.3	Pneumatic Polarisation (PP).....	12
1.4	Electric Polarisation (EP).....	14
1.5	Electric Polarisation and Height Adjustable (EP-H).....	16
1.6	With Hand Crank.....	18
1.7	For Heavy Horn Antennas.....	24
1.8	For Multiple Antennas.....	26
2	<b>ANTENNA MASTS</b> .....	29
2.1	Product Overview.....	30
2.2	Mini Mast (MM).....	32
2.3	Electrical Polarisation (MA-EP).....	34
2.4	Pneumatic Polarisation (MA-PP).....	36
2.5	Twin Pneumatic Polarisation (MA-TPP).....	38
2.6	Degree-wise Polarisation (MA-EP-DG).....	40
2.7	Antenna Masts (MA-XP-ET).....	42
2.8	Twin Masts with Electrical Polarisation (TW-EP).....	46
2.9	Twin Masts with Pneumatic Polarisation (TW-PP).....	48
3	<b>ANTENNA ADAPTERS</b> .....	51
3.1	Product Overview.....	52
4	<b>TURNTABLES</b> .....	57
4.1	Product Overview.....	58
4.2	Compact (CT).....	60
4.3	Compact – Height Adjustable (CTE).....	62
4.4	PVC (KT).....	64
4.5	Low Profile – Free Standing with Wooden Plate (DS-HA).....	66
4.6	Low Profile – Wooden Cover (DS-HE).....	68
4.7	Low Profile – Stainless Steel Cover (DS-S).....	70
4.8	High Load – Stainless Steel Cover (DT).....	72
4.9	High Load Dual – Stainless Steel Cover (DDT).....	76
5	<b>DYNAMOMETERS</b> .....	81
5.1	Product Overview.....	82
5.2	Coupled Free Roller (FRC).....	84
5.3	Free Standing (RPS-F).....	86
5.4	Integrated for Turntables (RPS-DT).....	88
5.5	Embedded for Chamber Floor (RPS-E).....	90
5.6	Features for RPS.....	92
5.7	Control Software (DYNAM-PRO).....	94
5.8	Driving Robot.....	96
6	<b>CONTROLLERS AND HAND CONTROL UNITS</b> .....	99
6.1	Product Overview.....	100
6.2	Controllers (CO).....	102
6.3	Hand Control Unit (HCU).....	104
6.4	USB Control (PC-USB).....	106
6.5	GPIB Interface Box.....	108



7	<b>FIBER OPTIC CABLES</b> .....	111
7.1	Fiber Optic Cables .....	112
7.2	Cable Length .....	112
7.3	POF / GOF Knowledge.....	113
8	<b>POSITIONING SYSTEMS</b> .....	115
8.1	Product Overview .....	116
8.2	Absorbing Clamp Positioners (KMS).....	118
8.3	Field Probe Positioners (FSM) .....	120
8.4	Mast Positioners (MP) .....	122
8.5	Mast Rotator (MR) .....	124
8.6	Wall Positioners (WP) .....	126
8.7	VSWR Positioners .....	128
9	<b>TURNDEVICES</b> .....	131
9.1	Product Overview .....	132
9.2	Turndevices (DE) .....	134
9.3	Combined Turndevices (DK) .....	146
10	<b>CUSTOMIZED POSITIONERS</b> .....	149
10.1	Product Overview .....	150
10.2	Swivel Arm Antenna Positioners (SAP) .....	152
10.3	Horizontal Positioners (HP) .....	154
10.4	Three Axis Positioners (XYZ) .....	156
10.5	C-Shape Antenna Positioner (CP) .....	160
10.6	Transmission Range Measuring Robot (TRMR) .....	162
11	<b>TEST TABLES</b> .....	165
11.1	Product Overview .....	166
11.2	Plastic Test Table Made of Polystyrene (PT-SD).....	168
11.3	Plastic Test Table Made of Rohacell® (PT-RH) .....	170
11.4	Wooden Test Tables for CISPR 25 (WT).....	172
11.5	Plastic Table for Rod Antennas (HT) .....	174
12	<b>WALL MOUNTING BRACKETS</b> .....	177
13	<b>PROJECTION SCREENS</b> .....	179
13.1	Product Overview .....	180
13.2	Free Standing .....	182
13.3	For Absorber Installation .....	184
14	<b>REACTION TIME TEST DEVICE</b> .....	187
	<b>LIST OF ABBREVIATIONS</b> .....	190
	<b>COMPANY PROFILE</b> .....	192





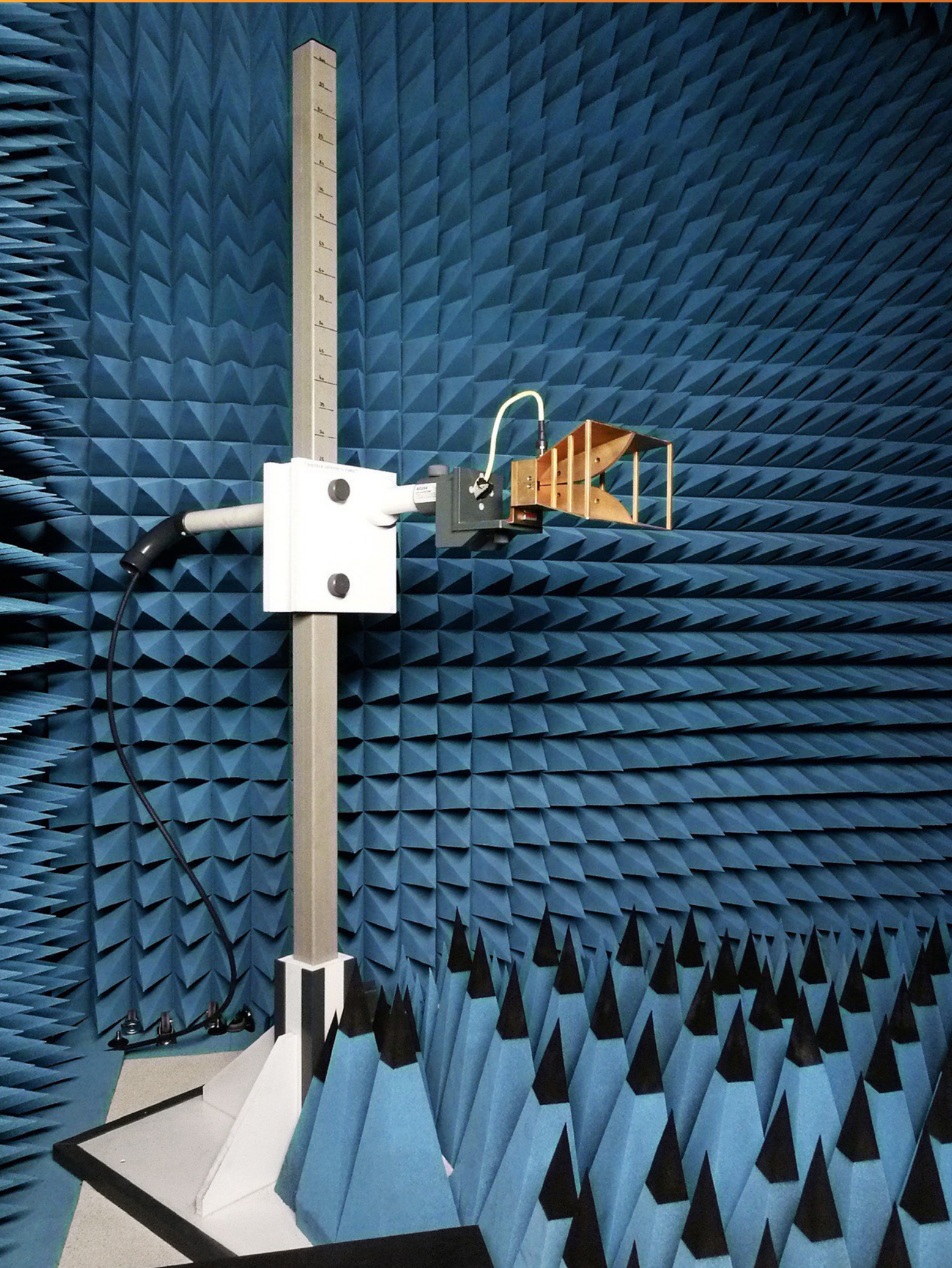



## | 1 | ANTENNA STANDS

Our manual height antenna stands are specifically designed to be used in EMC and antenna facilities, for measurements at a fixed height.

The metal free designs (except for castors and drive unit) have no influence to the measurement performance. The polarisation is available in three designs, manual, electric and pneumatic.

The latest introduction to the antenna stand range allows adjustable height in combination with electric polarisation. The stand can also be equipped with a manual hand crank. This allows easy movement and fast set up time, compared to a tripod.

### MANUAL POLARISATION (AS-MP)

- 700...2550 mm manual height adjustment
- Manual polarisation
- 6 kg load



### PNEUMATIC POLARISATION (AS-PP)

- 700...2550 mm manual height adjustment
- Pneumatic polarisation
- 6 kg load



## | 1.1 | PRODUCT OVERVIEW

### ELECTRIC POLARISATION (AS-EP)

- Fixed height
- Electric polarisation
- 6 kg load



### ELECTRIC POLARISATION AND HEIGHT ADJUSTABLE (AS-EP-H)

- 700...2500 mm manual height adjustment
- Electric polarisation
- 10 / 15 kg load



### WITH HAND CRANK

- 1000...4000 mm manual height adjustment
- Manual polarisation
- Up to 50 kg load
- Optional tilt



### FOR HEAVY HORN ANTENNAS

- 700...2000 mm manual height adjustment
- Manual polarisation
- 18 kg load
- Optional tilt

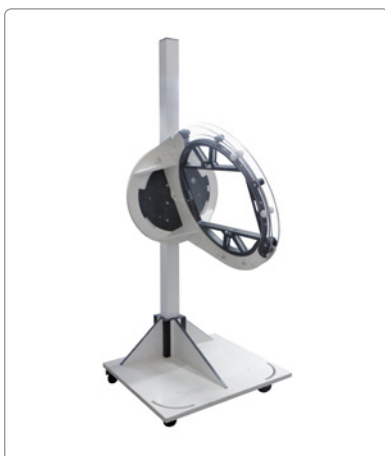

### FOR MULTIPLE ANTENNAS

- 700...1650 mm manual height adjustment
- Manual polarisation
- 6 kg load
- Mounting adapter for up to three horn antennas







## | 1.2 | MANUAL POLARISATION (MP)

The MP antenna stands have a manual adjustable measuring height, and are designed specifically for electromagnetic measurements in electromagnetic shielded chambers.

The MP antenna stands have no metal parts.

Polarisation is operated manually. Cams are located at the stops enabling the antenna bar height to be adjusted manually.

The antenna stands can be equipped with an optional available manual crank winch for moving the antenna support.

### ANTENNA STANDS – MANUAL POLARISATION (MP)

Type	Description	Article No.
AS 1500-MP	Adjustable height 700...1550 mm MP = Manual Polarisation	81000009
AS 2000-MP	Adjustable height 700...2050 mm	80000080
AS 2500-MP	Adjustable height 700...2550 mm	80000391

### ACCESSORIES

Type	Description	Article No.
-O	OATS version for AS series (only with –HK or –PP)	80004899
-PP	Optional pneumatic polarisation	80004900
-MT	Optional manual tilt (bore sight)	80000337
-HK	Hand crank for height adjustment	80004901
-10kg	Stronger version, max. antenna load up to 10 kg	80004902
-20kg	Stronger version, max. antenna load up to 20 kg	80004903
-PR 7/16	Polarisation rod for 7/16 antenna connector	80600029
-CW5	Counter weight 5 kg	80000135

### SCOPE OF DELIVERY

Type	Quantity
Operating manual	1 x

## TECHNICAL DATA

TYPE	AS 1500-MP	AS 2000-MP	AS 2500-MP
Antenna height adjustable between	700 mm...1550 mm	700 mm...2050 mm	700 mm...2550 mm
Total mast height	1669 mm	2169 mm	2669 mm
Material	PVC, Kömacel® & fiber glass, weatherproof		
Mast cross-section	60 mm x 60 mm		
Base L x W	900 mm x 600 mm (new version min. 893 mm x 893 mm)		
Antenna weight (at the end of antenna pipe)	max. 6 kg		
Polarisation manually	0° / 90° (vert. / hor.)		
Temperature range	+8 °C...+40 °C		





## | 1.3 | PNEUMATIC POLARISATION (PP)

The PP antenna stands are specifically designed for measurements in electromagnetic absorption chambers at a fixed measuring height.

Polarisation occurs using compressed air. A solenoid valve located outside of the chamber regulates the compressed air flow. The antenna bar height is manually adjustable.

The GPIB (IEEE 488) & LAN (TCP/IP) bus, when operated with the CO 3000 Controller, provides an additional control option for all functions.

### ANTENNA STANDS – PNEUMATIC POLARISATION (PP)

Type	Description	Article No.
AS 1500-PP	Adjustable height 700...1550 mm PP = Pneumatic Polarisation	80006758
AS 2000-PP	Adjustable height 700...2050 mm	80000082
AS 2500-PP	Adjustable height 700...2550 mm	80001082

### ACCESSORIES

Type	Description	Article No.
-10 kg	Stronger version, max. antenna load up to 10 kg	80006757
-PR 7/16	Polarisation rod for 7/16 antenna connector	80600029
-CW5	Counter weight 5 kg	80000135

### SCOPE OF DELIVERY

Type	Quantity
Interface to CO 3000	1 x
Power supply cable	1 x 3 m
Fiber optic cable	1 x 5 m
Pneumatic tube	2 x 12.5 m
Pneumatic wall-panel bulkhead fitting	2 x
Pneumatic service unit with control box	1 x
Operating manual	1 x

## TECHNICAL DATA

TYPE	AS 1500-PP	AS 2000-PP	AS 2500-PP
Antenna height adjustable manually between	700...1550 mm	700...2050 mm	700...2550 mm
Total mast height	1669 mm	2169 mm	2669 mm
Material	Kömacel® & fiber glass, weatherproof		
Mast cross-section	60 mm x 60 mm		
Base L x W	900 mm x 600 mm (new version min. 893 mm x 893 mm)		
Antenna weight (at the end of antenna pipe)	max. 6 kg		
Polarisation	0° / 90° (vert. / hor.)		
Polarisation time 0° / 90°	approx. 3 sec		
Polarisation drive	pneumatic rotation cylinder via solenoid valve		
Control	microcontroller by fiber optic cable		
Air Pressure	min. 6 bar		
Operating voltage	110 / 230 V (50 / 60 Hz)		
Current consumption	0.6 A		
Temperature range	+8 °C...+40 °C		





## | 1.4 | ELECTRIC POLARISATION (EP)

The EP antenna stands are specifically designed for measurements in electromagnetic absorption chambers at a fixed measuring height. An enclosed DC motor, controlled via a fiber optic cable, is used during polarisation. Adjustable limit switches at end position enable a security feature.

The GPIB (IEEE 488) & LAN (TCP/IP) bus, when operated with the CO 3000 Controller, provides an additional control option for all functions.

### ANTENNA STANDS – ELECTRIC POLARISATION (EP)

Type	Description	Article No.
AS 1500-EP	Fix height 1550 mm	80000083
	EP = Electrical Polarisation	
AS 2000-EP	Fix height 2050 mm	80000082
AS 2500-EP	Fix height 2550 mm	80005023

### ACCESSORIES

Type	Description	Article No.
-10 kg	Stronger version, max. antenna load up to 10 kg	80004902
-H	Height adjustable AS-EP version	80005555
-PR 7/16	Polarisation rod for 7/16 antenna connector	80600029
-CW5	Counter weight 5 kg	80000135

### SCOPE OF DELIVERY

Type	Quantity
Interface to CO 3000	1 x
Power supply cable	1 x 5 m
Fiber optic cable	1 x 5 m, 1 x 10 m
FSMA	2 x
Operating manual	1 x



## TECHNICAL DATA

TYPE	AS 1500-EP	AS 2000-EP	AS 2500-EP
Antenna height fixed at	1550 mm	2050 mm	2550 mm
Total mast height	1720 mm	2220 mm	2720 mm
Material	PVC, Kömacel® & fiber glass, weatherproof		
Mast cross-section	60 mm x 60 mm		
Base L x W	900 mm x 600 mm (new version min. 893 mm x 893 mm)		
Antenna weight (at the end of antenna pipe)	max. 6 kg		
Polarisation	0° / 90° (vert. / hor.)		
Polarisation time 0° / 90°	approx. 4 sec		
Polarisation drive	DC motor via belt drive		
Control	microcontroller by fiber optic cable		
Control cable	fiber optic (polymer type)		
Operating voltage	230 V 50 / 60 Hz (optional 110 V)		
Current consumption	1.25 A		
Temperature range	+8 °C...+40 °C		

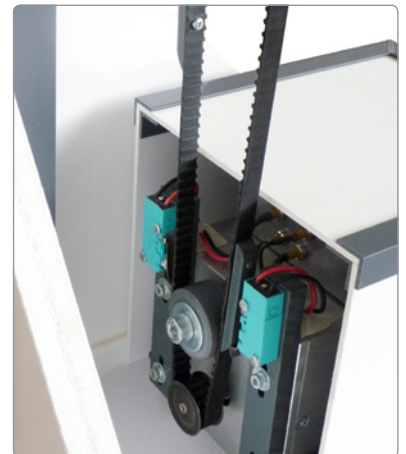



## | 1.5 | ELECTRIC POLARISATION AND HEIGHT ADJUSTABLE (EP-H)

The EP-H antenna stands are specifically designed for measurements in electromagnetic absorption chambers. The antenna height could be adjusted manually. An enclosed DC motor, controlled via a fiber optic cable, is used during polarisation. Adjustable limit switches at end position enable a security feature.

The GPIB (IEEE 488) & LAN (TCP/IP) bus, when operated with the CO 3000 Controller, provides an additional control option for all functions.

### ANTENNA STANDS – ELECTRIC POLARISATION AND HEIGHT ADJUSTABLE (EP-H)

Type	Description	Article No.
AS 2000-EP-H	Adjustable height 700...2000 mm	80005555
	EP-H = Electrical Polarisation and Height Adjustable	
AS 2500-EP-H-15kg	Adjustable height 700...2500 mm	80007150

### ACCESSORIES

Type	Description	Article No.
-15 kg	Stronger version, max. antenna load up to 15 kg	On request
-20 kg	Stronger version, max. antenna load up to 20 kg	On request
-PR 7/16	Polarisation rod for 7/16 antenna connector	80600029
-CW5	Counter weight 5 kg	80000135

### SCOPE OF DELIVERY

Type	Quantity
Interface to CO 3000	1 x
Power supply cable	1 x 5 m
Fiber optic cable	1 x 5 m, 1 x 10 m
FSMA	2 x
Operating manual	1 x

## TECHNICAL DATA

TYPE	AS 2000-EP-H	AS 2500-EP-H-15KG
Antenna height manually adjustable between	700...2000 mm	700...2500 mm
Total mast height	2169 mm	2674 mm
Material	PVC, Kömacel® & fiber glass, weatherproof	
Mast cross-section	60 mm x 60 mm	100 mm x 100 mm
Base L x W	908 mm x 608 mm	1058 mm x 658 mm
	(new version min. 893 mm x 893 mm)	
Antenna weight (at the end of antenna pipe)	max. 10 kg	max. 15 kg
Polarisation	0° / 90° (vert. / hor.)	
Polarisation time 0° / 90°	approx. 4 sec	
Polarisation drive	DC motor via cardan drive	
Control	microcontroller board	
Control cable	fiber optic (polymer type)	
Operating voltage	230 V 50 / 60 Hz (optional 110 V)	
Current consumption	1.25 A	
Temperature range	+8 °C...+40 °C	

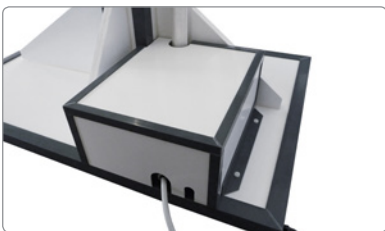

## | 1.6 | WITH HAND CRANK – PART 1

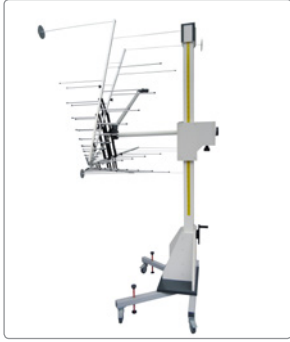

The AS2850-MP-HK-MT-15kg-ST antenna stand is constructed for heavy antennas and specifically designed for measurements in electromagnetic absorption chambers and Open Area Test Sites. The antenna height is adjustable by hand crank to provide an easy height adjustment for the heavy antennas. The used casters enable an easy movement of the whole antenna stand and are lockable.

The polarisation occurs manually by the antenna rod, specific antenna adapters are optional available. The tilt angle is manually adjustable up to 40°.

Used materials are POM, fiberglass & PVC. There are no metal parts, excepting the casters. The antenna stand design is optimized for Schwarzbeck antenna STLP 9128 E.

### ANTENNA STANDS – WITH HAND CRANK (MP-HK-MT-ST)

Type	Description	Article No.
AS2850-MP-HK-MT-15kg-ST	Adjustable height by hand crank 1126...2850 mm	80005790
	MP = Manual Polarisation	
	HK = Hand Crank	
	MT = Manual Tilt	
	ST = Sideways mounted Tube	

### ACCESSORIES

Type	Description	Article No.
-PR 7/16	Polarisation rod for 7 / 16 antenna connector	80600029
-CW5	Counter weight 5 kg	80000135

### SCOPE OF DELIVERY

Type	Quantity
Operating manual	1 x

TECHNICAL DATA

TYPE	AS2850-MP-HK-MT-15KG-ST
Antenna height adjustable by hand crank from	1126 mm...2850 mm (at centreline of antenna)
Total mast height	2896 mm
Material	POM, fiber glass & PVC, weatherproof
Mast cross-section	min. 100 mm x 100 mm
Base L x W	766 mm x 1125 mm
Antenna weight	max. 15 kg
Polarisation manual adjustable between	0° / 90° (vert. / hor.)
Tilt angle manual adjustable between	-10°...+40°
Antenna stand weight	50 kg
Temperature range	+8 °C...+40 °C

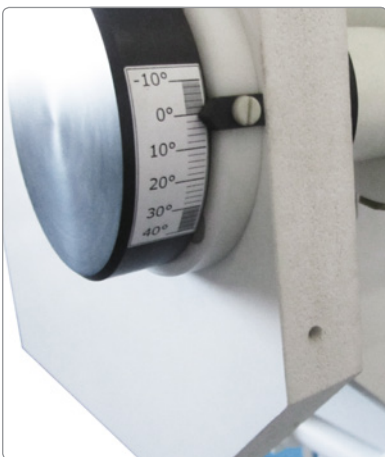
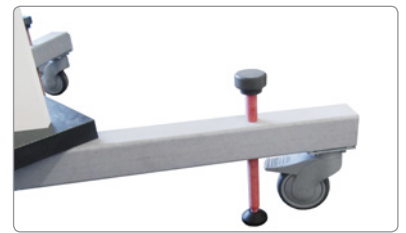
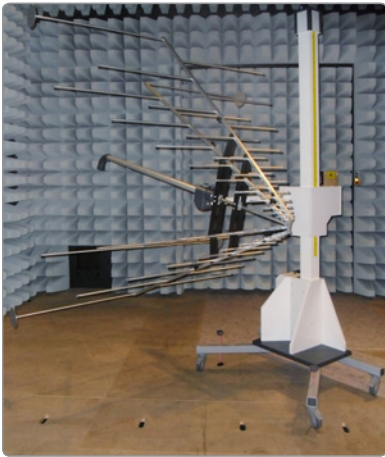



## | 1.6 | WITH HAND CRANK – PART 2



The AS3000-PP-HK-MT-ST antenna stands have a manual adjustable measuring height by hand crank, and are designed specifically for electromagnetic measurements in electromagnetic shielded chambers or temporary in Open Area Test Sites.

The AS3000-PP-HK-MT-ST antenna stands have no metal parts (excepting the rollers). Polarisation is manually adjustable. The antenna stand is equipped with a manual crank winch for moving the antenna basket between 1.4 and 3 m.

### ANTENNA STANDS – WITH HAND CRANK (PP-HK-MT-ST)

Type	Description	Article No.
AS3000-PP-HK-MT-ST	Adjustable height by hand crank 1400...3000 mm	80006606
	PP = Pneumatic Polarisation	
	HK = Hand Crank	
	MT = Manual Tilt	
	ST = Sideways mounted Tube	

### ACCESSORIES

Type	Description	Article No.
-PR 7/16	Polarisation rod for 7/16 antenna connector	80600029
-CW5	Counter weight 5 kg	80000135

### SCOPE OF DELIVERY

Type	Quantity
Operating manual	1 x

TECHNICAL DATA

TYPE	AS 3000-PP-HK-MT-ST
Antenna height adjustable by hand crank from	1400 mm...3000 mm
Total mast height	3460 mm
Material	fiber glass & PVC, weatherproof
Mast cross-section	100 mm x 100 mm
Base L x W	1235 mm x 1235 mm
Antenna weight	max. 15 kg (at the end of the antenna pipe)
Polarisation pneumatic	0° / 90° (vert. / hor.)
Polarisation drive	pneumatic actuator via solenoid valve
Control	microcontroller board by fiber optic
Air Pressure	min. 6 bar
Tilt angle manual adjustable between	0°...+30°
Antenna stand weight	50 kg
Temperature range	+8 °C...+40 °C

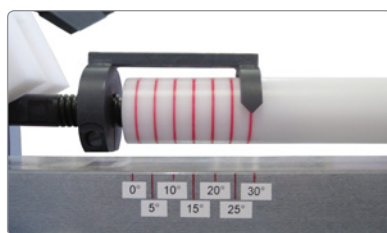
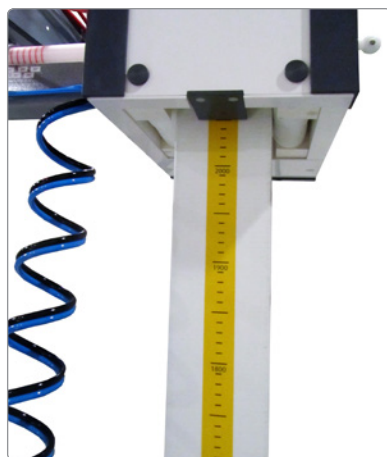



## | 1.6 | WITH HAND CRANK – PART 3

The AS 4000-MP-HK antenna stands have a manual adjustable measuring height by hand crank, and are designed specifically for electromagnetic measurements in electromagnetic shielded chambers or temporary in Open Area Test Sites.

The AS 4000-MP-HK antenna stands have no metal parts (excepting the rollers).

Polarisation is manually adjustable. The antenna stand is equipped with a manual crank winch for moving the antenna basket between 1 and 4 meters).

### ANTENNA STANDS – WITH HAND CRANK (MP-HK)

Type	Description	Article No.
AS 4000-MP-HK	Adjustable height by hand crank 1000...4000 mm	80006605
	MP = Manual Polarisation	
	HK = Hand Crank	

### ACCESSORIES

Type	Description	Article No.
-O	OATS version for AS series (only with –HK or –PP)	80004899
-PP	Optional pneumatic polarisation	80004900
-MT	Optional manual tilt (bore sight)	80000337
-10kg	Stronger version, max. antenna load up to 10 kg	80004902
-20kg	Stronger version, max. antenna load up to 20 kg	80004903
-PR 7/16	Polarisation rod for 7/16 antenna connector	80600029
-CW5	Counter weight 5 kg	80000135

### SCOPE OF DELIVERY

Type	Quantity
Operating manual	1 x

## TECHNICAL DATA

TYPE	AS 4000-MP-HK
Antenna height adjustable by hand crank from	1000 mm...4000 mm
Total mast height	4300 mm
Material	fiber glass & PVC, weatherproof
Mast cross-section	60 mm x 60 mm
Base L x W	900 mm x 900 mm (new version min. 893 mm x 893 mm)
Antenna weight	max. 6 kg (at the end of the antenna pipe)
Polarisation manual adjustable between	0° / 90° (vert. / hor.)
Antenna stand weight	50 kg
Temperature range	+8 °C...+40 °C

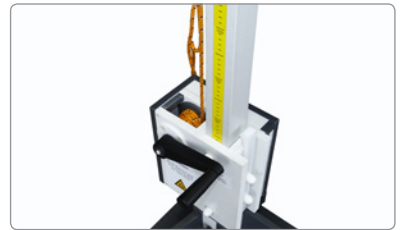
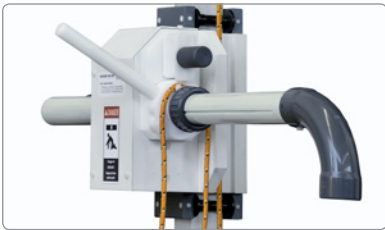



## | 1.7 | FOR HEAVY HORN ANTENNAS

The AS2000-MP-18kg-SR is an antenna stand enabling the easy polarisation of heavy antennas in a fix but adjustable height. The complete design is made for using in electromagnetic absorption chambers, free from metal parts to minimise the influence on the measurement results.

The rotating axis is in the center of the antenna so the height and direction do not change during polarisation.

The adaption of the antenna is done by an adaption ring which differs from the antenna to be fixed. In -HK execution (optionally) the antenna stand has a hand crank for the easier height changing.

### ANTENNA STAND – FOR HEAVY HORN ANTENNAS (MP-SR)

Type	Description	Article No.
AS2000-MP-18kg-SR	Adjustable height 700...2000 mm	80006789
	MP =Manual Polarisation	
	SR = Sideways mounted Ring	

### ACCESSORIES

Type	Description	Article No.
-HK	Hand crank for up / down movement	On request
-EP	Electric polarisation	On request
-PP	Pneumatic polarisation	On request
-MT	Manual tilt	On request
-XXkg	Other loads	On request

### SCOPE OF DELIVERY

Type	Quantity
Operating manual	1 x



TECHNICAL DATA

TYPE	AS 2000-MP-18KG-SR
Antenna height adjustable between	700 ... 2000 mm
Total mast height	2550 mm
Permissible load	18 kg
Material of the structure	PVC, POM, fiber glass, PC, PTFE, ... all non conductive
Mast cross section	100 × 100 mm
Base L x W	approx. 1450 × 1230 mm
Polarisation of the antenna	manually (optionally: pneumatic or electric)
Antenna adaption	ø 800 mm ring
Antenna tilt	none (optionally: manual tilt 0...45°, others on request)
Temperature range	+8 °C...+40 °C





## | 1.8 | FOR MULTIPLE ANTENNAS

The AS1600-MP-3 antenna stand has a manual adjustable measuring height, and is designed specifically for electromagnetic measurements in electromagnetic shielded chambers.

The AS1600-MP-3 antenna stand has no metal parts.

Polarisation is operated manually of each antenna. The holder-plate for the two smaller antennas can be adjusted in a height range of 350 mm and in a distance of 100 and 170 mm to enable a similar measurement height and distance of each horn antenna.

The antenna stand can be equipped with an optional available manual crank winch for moving the antenna support.

### ANTENNA STAND – FOR MULTIPLE ANTENNAS (MP-3)

Type	Description	Article No.
AS1600-MP-3	Adjustable height 710...1650 mm MP-3 = Manual Polarisation for three horn antennas	80000390

### ACCESSORIES

Type	Description	Article No.
-O	OATS version for AS series (only with -HK or -PP)	80004899
-PP	Optional pneumatic polarisation	80004900
-MT	Optional manual tilt (bore sight)	80000337
-HK	Hand crank for height adjustment	80004901
-10kg	Stronger version, max. antenna load up to 10 kg	80004902
-20kg	Stronger version, max. antenna load up to 20 kg	80004903
CW5	Counter weight 5 kg	80000135

### SCOPE OF DELIVERY

Type	Quantity
Operating manual	1 x

TECHNICAL DATA

TYPE	AS 1600-MP-3
Antenna height adjustable between	710 mm...1650 mm
Total mast height	1700 mm
Material	PVC, Kömacel® & fiber glass, weatherproof
Mast cross-section	60 mm x 60 mm
Base L x W	960 mm x 600 mm
Antenna weight	max. 6 kg (at the end of antenna pipe)
Polarisation manually	0° / 90° (vert. / hor.)
Temperature range	+8 °C...+40 °C









### | 2 | ANTENNA MASTS

Antenna masts are an integral part of EMC and RF measurement systems. innco systems masts are renowned worldwide as the standard benchmark. Available in manual or automatic, using either pneumatic and or electric drives, the antenna mast design has the capacity to carry antennas of 6 kgs (MM) and 10 kgs (MA) as standard. Higher loads are available upon request.

Unique designs with integrated pneumatic compressors, high speed, high accuracy, twin mast, bore site function and loads as high as 30 kgs, are all part of innco systems supplied products, to a worldwide customer listing.

#### MINI MAST (MM)

- 1000...4000 mm electrical height adjustment
- Pneumatic polarisation
- 6 kg load



#### ELECTRICAL POLARISATION (MA-EP)

- 1000...6000 mm electrical height adjustment
- Electric polarisation
- 10 kg load





## | 2.1 | PRODUCT OVERVIEW

### PNEUMATIC POLARISATION (MA-PP)

- 1000...6000 mm electrical height adjustment
- Pneumatic polarisation
- 10 kg load



### TWIN PNEUMATIC POLARISATION (MA-TPP)

- 1000...6000 mm electrical height adjustment
- Pneumatic polarisation
- 10 kg load
- Second antenna support



### DEGREEWISE POLARISATION (MA-EP-DG)

- 1000...6000 mm electrical height adjustment
- Polarisation 0°...360° (1° steps)
- 10 kg load



### ANTENNA MAST (MA-XP-ET)

- 1000...6000 mm electrical height adjustment
- Pneumatic polarisation
- 12°...45° tilt angle
- 10 kg load



### TWIN MAST WITH ELECTRICAL POLARISATION (TW-EP)

- 1000...10000 mm electrical height adjustment
- Electric polarisation
- 20 kg load



### TWIN MAST WITH PNEUMATIC POLARISATION (TW-PP)

- 1000...6000 mm electrical height adjustment
- Pneumatic polarisation
- 20 kg load





## | 2.2 | MINI MAST (MM)

The Mini Mast is suitable for use in either open areas or in electromagnetic absorption chambers. Guy wires and anchoring pins are available for antenna installation in open areas. It has no metal parts above the drive unit. Special designs are available upon request. The mast tube can be delivered in 2 separate parts for easy transportation and storage.

Adapters for all commercially available antennas are available. Special designs are available on request. All antennas rotate around their own axis during polarisation to eliminate any elevation errors.

Limit switches and the general mechanical design ensure a reliable system operation.

The GPIB (IEEE 488) & LAN (TCP/IP) bus, when operated with the CO 3000 Controller, provides an additional control option for all functions.

MINI MAST (MM)		
Type	Description	Article No.
MM 2000-PP	Electric height adjustment 1000...2000 mm, max. load 6 kg PP = Pneumatic Polarisation	80000168
MM 4000-PP	Electric height adjustment 1000...4000 mm, max. load 6 kg	80000073

ACCESSORIES		
Type	Description	Article No.
-MT	Manual tilt – bore sight – option	80000337
-MP	Optional manual polarisation	80004904
-PR 7/16	Polarisation rod for 7/16 antenna connector	80600029

SCOPE OF DELIVERY	
Type	Quantity
Interface to CO 3000	1 x
Power supply cable	1 x 5 m
Fiber optic cable	2 x 5 m, 1 x 10 m
FSMA	4 x
Pneumatic tube	1 x 12 m
Pneumatic wall-panel bulkhead fitting	1 x
Pressure reducing valve	1 x
Polarisation rod shifttable	450 mm
Operating manual	1 x

## TECHNICAL DATA

TYPE	MM 2000-PP	MM 4000-PP
Antenna height	1000...2000 mm	1000...4000 mm
Total mast height	2300 mm	4300 mm
Material	PVC + GFK, weatherproof	
Mast cross-section	60 mm x 60 mm	
Base L x W	800 mm x 600 mm	
Antenna weight	max. 6 kg (at the end of the antenna pipe)	
Positioning speed adjustable	2...16 cm / sec	
Positioning accuracy	typical $\pm 2$ mm	
Polarisation	0° / 90° (vert. / hor.)	
Polarisation time 0° / 90°	approx. 4 sec (at 6 bar)	
Polarisation drive	pneumatic rotation cylinder	
Mast drive	1 toothed belt (Kevlar® cord reinforced)	
Air pressure	min. 6 bar	
Control	microcontroller & solenoid valve	
Operating voltage	230 V 50 / 60 Hz (optional 110 V)	
Current consumption	max. 1.6 A	
Temperature range	+8 °C...+40 °C	





## | 2.3 | ELECTRICAL POLARISATION (MA-EP)

The MA-EP antenna masts are suitable for use in either open areas or in electromagnetic absorption chambers. Guy wires and anchoring pins are available for antenna installation in open areas. Metal parts are located only in the base plate and the drive mechanism (max. 0.3 m above ground level).

Adapters for all commercially available antennas are available. Special designs are available on request. All antennas during polarisation rotate around their axis so as to eliminate any elevation errors.

Limit switches and the general mechanical design ensure a reliable system operation.

The GPIB (IEEE 488) & LAN (TCP/IP) bus, when operated with the CO 3000 Controller, provides an additional control option for all functions.

### ANTENNA MASTS WITH ELECTRICAL POLARISATION (MA-EP)

Type	Description	Article No.
MA 2000-EP	Electric height adjustment 1000...2000 mm, max. load 10 kg EP = Electrical Polarisation	80000273
MA 4000-EP	Electric height adjustment 1000...4000 mm, max. load 10 kg	80000074
MA 6000-EP	Electric height adjustment 1000...6000 mm, max. load 10 kg	80000075

### ACCESSORIES

Type	Description	Article No.
-O	OATS version for MA series	80000331
-PP	Optional pneumatic polarisation	80004906
-XP	Optional pneumatic polarisation by internal compressor	80005650
-MT	Optional manual tilt bore sight (only with -PP)	80000337
-HK	Hand crank for height adjustment (without drive unit)	80004907
-15kg	Max. antenna load up to 15 kg incl. CW5	80004908
-HS	Max. antenna mast speed up to 25 cm/s	80005564
-CISPR16	Antenna rod extend to 2000 mm	80005111
-PR 7/16	Polarisation rod for 7/16 antenna connector	80600029

### SCOPE OF DELIVERY

Type	Quantity
Interface to CO 3000	1 x
Power supply cable	1 x 5 m
Fiber optic cable	2 x 5 m, 1 x 10 m
FSMA	4 x
Polarisation rod shiftable	450 mm
Operating manual	1 x

## TECHNICAL DATA

TYPE	MA 2000-EP	MA 4000-EP	MA 6000-EP
Antenna height	1000...2000 mm	1000...4000 mm	1000...6000 mm
Total mast height	2600 mm	4600 mm	6600 mm
Material	PVC + fiber glass, weatherproof		
Mast cross-section	100 mm x 100 mm		
Base L x W	1080 mm x 1080 mm		
Antenna weight	max. 10 kg (15 kg available)		
Positioning speed adjustable	1...12 cm / sec (15 or 25 cm / sec available)		
Positioning accuracy	better $\pm$ 10 mm		
Polarisation	0° / 90° (vert. / hor.)		
Positioning time 0° / 90°	approx. 3 sec		
Antenna support drive	2 toothed belts (Kevlar® cord reinforced)		
Motor	electronic EC motor 150 W		
Control cable	fiber optic (polymer type)		
Drive unit	shielded and radio interference suppressed 20 dB under Class B		
Total weight	70 kg	75 kg	80 kg
Operating voltage	230 V 50 / 60 Hz (optional 110 V)		
Current consumption	max. 1.6 A		
Temperature range	+8 °C...+40 °C		

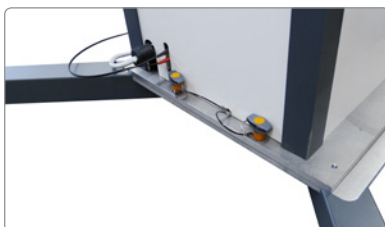



## | 2.4 | PNEUMATIC POLARISATION (MA-PP)

The MA-PP antenna masts are suitable for use in either open areas or in electromagnetic absorption chambers. Guy wires and anchoring pins are available for antenna installation in open areas. Metal parts are located only in the base plate and the drive mechanism (max. 0.3 m above ground level).

Adapters for all commercially available antennas are available. Special designs are available on request. All antennas during polarisation rotate around their axis so as to eliminate any elevation errors.

Limit switches and the general mechanical design ensure a reliable system operation.

The GPIB (IEEE 488) & LAN (TCP/IP) bus, when operated with the CO 3000 Controller, provides an additional control option for all functions.

### ANTENNA MASTS WITH PNEUMATIC POLARISATION (MA-PP)

Type	Description	Article No.
MA 4000-PP	Electric height adjustment 1000...4000 mm, max. load 10 kg PP = Pneumatic Polarisation	80006714
MA 6000-PP	Electric height adjustment 1000...6000 mm, max. load 10 kg	80007156

### ACCESSORIES

Type	Description	Article No.
-O	OATS version for MA series	80000331
-XP	Optional pneumatic polarisation by internal compressor	80005650
-MT	Optional manual tilt bore sight (only with -PP)	80000337
-HK	Hand crank for height adjustment (without drive unit)	80004907
-15kg	Max. antenna load up to 15 kg incl. CW5	80004908
-HS	Max. antenna mast speed up to 25 cm/s	80005564
-CISPR16	Antenna rod extend to 2000 mm	80005111
-PR 7/16	Polarisation rod for 7/16 antenna connector	80600029

### SCOPE OF DELIVERY

Type	Quantity
Interface to CO 3000	1 x
Power supply cable	1 x 5 m
Fiber optic cable	2 x 5 m, 1 x 10 m
FSMA	4 x
Pneumatic tube	1 x 12.5 m
Pneumatic wall-panel bulkhead fitting	1 x
Pressure reducing valve	1 x
Polarisation rod shifttable	450 mm
Operating manual	1 x



TECHNICAL DATA		
TYPE	MA 4000-PP	MA 6000-PP
Antenna height	1000...4000 mm	1000...6000 mm
Total mast height	max. 4600 mm	max. 6600 mm
Material	PVC + fiber glass, weatherproof	
Mast cross-section	100 mm x 100 mm	
Base L x W	1080 mm x 1080 mm	
Antenna weight	max. 10 kg (15 kg available)	
Positioning speed adjustable	1...12 cm / sec (15 or 25 cm / sec available)	
Positioning accuracy	better $\pm$ 10 mm ( $\pm$ 2 mm)	
Polarisation	0° / 90° (vert. / hor.)	
Polarisation drive	pneumatic rotation cylinder	
Positioning time 0° / 90°	approx. 4 sec (at 6 bar)	
Antenna support drive	1 toothed belt (Kevlar® cord reinforced)	
Motor	electronic EC motor 150 W	
Control cable	fiber optic (polymer type)	
Drive unit	shielded and radio interference suppressed 20 dB under Class B	
Operating voltage	230 V 50 / 60 Hz (optional 110 V)	
Current consumption	max. 1.6 A	
Temperature range	+8 °C...+40 °C	





## | 2.5 | TWIN PNEUMATIC POLARISATION (MA-TPP)

The MA-TPP antenna masts are suitable for use in either open areas or in electromagnetic absorption chambers. Guy wires and anchoring pins are available for antenna installation in open areas. Metal parts are located only in the base plate and the drive mechanism (max. 0.3 m above ground level).

Adapters for all commercially available antennas are available. Special designs are available on request. All antennas during polarisation rotate around their axis so as to eliminate any elevation errors.

Limit switches and the general mechanical design ensure a reliable system operation.

The GPIB (IEEE 488) & LAN (TCP/IP) bus, when operated with the CO 3000 Controller, provides an additional control option for all functions.

ANTENNA MASTS WITH TWIN PNEUMATIC POLARISATION (MA-TPP)		
Type	Description	Article No.
MA 4000-TPP	Electric height adjustment 1000...4000 mm, max. load 10 kg	80007163
	TPP = Twin Pneumatic Polarisation	
MA 6000-TPP	Electric height adjustment 1000...6000 mm, max. load 10 kg	80007164

ACCESSORIES		
Type	Description	Article No.
-O	OATS version for MA series	80000331
-XP	Optional pneumatic polarisation by internal compressor	80005650
-MT	Optional manual tilt bore sight (only with -PP)	80000337
-HK	Hand crank for height adjustment (without drive unit)	80004907
-15kg	Max. antenna load up to 15 kg incl. CW5	80004908
-HS	Max. antenna mast speed up to 25 cm/s	80005564
-CISPR16	Antenna rod extend to 2000 mm	80005111
-PR 7/16	Polarisation rod for 7/16 antenna connector	80600029

SCOPE OF DELIVERY	
Type	Quantity
Interface to CO 3000	1 x
Power supply cable	1 x 5 m
Fiber optic cable	2 x 5 m, 1 x 10 m
FSMA	4 x
Pneumatic tube	1 x 12.5 m
Pneumatic wall-panel bulkhead fitting	1 x
Polarisation rod shiftable	450 mm
Operating manual	1 x

TECHNICAL DATA		
TYPE	MA 4000-TPP	MA 6000-TPP
Antenna height	1000...4000 mm	1000...6000 mm
Total mast height	max. 4600 mm	max. 6600 mm
Material	PVC + fiber glass, weatherproof	
Mast cross-section	100 mm x 100 mm	
Base L x W	1080 mm x 1080 mm	
Antenna weight	max. 10 kg (15 kg available)	
Positioning speed adjustable	1...12 cm / sec (15 or 25 cm / sec available)	
Positioning accuracy	better $\pm 10$ mm ( $\pm 2$ mm)	
Polarisation	0° / 90° (vert. / hor.)	
Polarisation drive	pneumatic rotation cylinders	
Positioning time 0° / 90°	approx. 4 sec (at 6 bar)	
Second Antenna Support		
Adjustable direction	0° (parallel) to 10°	
Rod shiftable	approx. 300 mm	
Antenna support drive	1 toothed belt (Kevlar® cord reinforced)	
Motor	electronic EC motor 150 W	
Control cable	fiber optic (polymer type)	
Drive unit	shielded and radio interference suppressed 20 dB under Class B	
Operating voltage	230 V 50 / 60 Hz (optional 110 V)	
Current consumption	max. 1.6 A	
Temperature range	+8 °C...+40 °C	





## | 2.6 | DEGREEWISE POLARISATION (MA-EP-DG)

The MA-EP-DG antenna masts are suitable for use in either open areas or in electromagnetic absorption chambers. Guy wires and anchoring pins are available for antenna installation in open areas. Metal parts are located only in the base plate and the drive mechanism (max. 0.3 m above ground level).

Adapters for all commercially available antennas are available. Special designs are available on request. All antennas during polarisation rotate around their axis so as to eliminate any elevation errors.

Limit switches and the general mechanical design ensure a reliable system operation.

The GPIB (IEEE 488) & LAN (TCP/IP) bus, when operated with the CO 3000 Controller, provides an additional control option for all functions.

ANTENNA MASTS WITH DEGREEWISE POLARISATION (MA-EP-DG)		
Type	Description	Article No.
MA 4000-EP-DG	Electric height adjustment 1000...4000 mm, max. load 10 kg EP = Electric Polarisation DG = Degreewise Polarisation	80005578
MA 6000-EP-DG	Electric height adjustment 1000...6000 mm, max. load 10 kg	80005579

ACCESSORIES		
Type	Description	Article No.
-O	OATS version for MA series	80000331
-MT	Optional manual tilt bore sight (only with -PP)	80000337
-HK	Hand crank for height adjustment (without drive unit)	80004907
-15kg	Max. antenna load up to 15 kg incl. CW5	80004908
-HS	Max. antenna mast speed up to 25 cm/s	80005564
-CISPR16	Antenna rod extend to 2000 mm	80005111
-PR 7/16	Polarisation rod for 7/16 antenna connector	80600029

SCOPE OF DELIVERY	
Type	Quantity
Interface to CO 3000	2 x
Power supply cable	1 x 5 m
Fiber optic cable	4 x 5 m, 2 x 10 m
FSMA	8 x
Polarisation rod shiftable	450 mm
Operating manual	1 x

TECHNICAL DATA		
TYPE	MA 4000-EP-DG	MA 6000-EP-DG
Antenna height	1000...4000 mm	1000...6000 mm
Total mast height	max. 4600 mm	max. 6600 mm
Material	PVC + fiber glass, weatherproof	
Mast cross-section	100 mm x 100 mm	
Base L x W	1080 mm x 1080 mm	
Antenna weight	max. 10 kg (15 kg available)	
Positioning speed adjustable between	3 to 12 cm / sec	
Positioning accuracy	better $\pm$ 10 mm	
Polarisation	0°...360° (1° steps)	
Positioning time 0°...360°	approx. 10 sec	
Polarisation accuracy	better $\pm$ 1°	
Antenna support drive	2 toothed belts (Kevlar® cord reinforced)	
Motor	electronic EC motor 150 W	
Control cable	fiber optic (polymer type)	
Drive unit	shielded and radio interference suppressed 20 dB under Class B	
Operating voltage	230 V 50 / 60 Hz (optional 110 V)	
Current consumption	max. 2.2 A	
Temperature range	+8 °C...+40 °C	





## | 2.7 | ANTENNA MASTS (MA-XP-ET)

The MA-XP-ET antenna masts are compliant with CISPR 16-1-4 BORESIGHT requirements. Metal parts are located only in the base plate and the drive mechanism (max. 0.4 m above ground level). Limit switches and the general mechanical design provide a safe system operation.

The separate controlled motors support simultaneous movement with both independent changing of height and tilt and also an automatic but configurable link of both values. (tilt while height change).

The GPIB (IEEE 488) & LAN (TCP/IP) bus, when operated with the CO 3000 Controller, provides an additional control option for all functions.

ANTENNA MASTS (MA-XP-ET)		
Type	Description	Article No.
MA4640-XP-ET	Electric height adjustment 1000...4000 mm (tilted), 1000...4640 mm (not tilted), max. load 10 kg XP = Pneumatic Polarisation by internal compressor (no compressed air needed) ET = Electric Tilt adjustment	80006803
MA6000-XP-ET	Electric height adjustment 1000...5400 mm (tilted), 1000...6000 mm (not tilted), max. load 10 kg	80005544

ACCESSORIES		
Type	Description	Article No.
-O	OATS version for MA series	80000331
-MT	Optional manual tilt bore sight (only with-PP or -XP)	80000337
-HK	Hand crank for height adjustment (without drive unit)	80004907
-15kg	Max. antenna load up to 15 kg incl. CW5	80004908
-HS	Max. antenna mast speed up to 25 cm/s	80005564
-CISPR16	Antenna rod extend to 2000 mm	80005111
-PR 7/16	Polarisation rod for 7/16 antenna connector	80600029

SCOPE OF DELIVERY	
Type	Quantity
Interface to CO 3000	2 x
Power supply cable	1 x 5 m
Fiber optic cable	4 x 5 m, 2 x 10 m
FSMA	8 x
Polarisation rod shiftable	450 mm
Operating manual	1 x



TECHNICAL DATA			
TYPE		MA 4640-XP-ET	MA 6000-XP-ET
Antenna height (horizontal)	tilted	1000 ... 4000 mm <sup>1</sup>	1000 ... 5400 mm
	not tilted	1000 ... 4640 mm	1000 ... 6000 mm
Total mast height		max. 5200 mm	max. 6600 mm
Antenna weight		max. 10 kg	
Material		PVC + RFP, weatherproof	
Mast cross-section		100 mm x 100 mm	
Base L x W		1080 mm x 1080 mm	
Positioning speed adjustable		1 ... 12 cm / sec (15 or 20 cm / sec available)	
Positioning accuracy		better ± 3 mm	
Pneumatic polarisation		0° / 90° (vert. / hor.)	
Positioning time 0° / 90°		approx. 4 sec	
Polarisation accuracy		better ± 0.1°	
Air pressure needed		none (internal DC compressor)	
Tilt angle		-12°...45°	
Tilt speed		7.5 ° / sec	
Tilt accuracy		better ± 0.5°	
Antenna support drive		2 toothed belts (Kevlar® cord reinforced)	
Motor		2 electronic EC motors (max. 150 W) separate controlled for simultaneous movements	
Control		microcontroller	
Control modes supported in CO 3000 controller		<ul style="list-style-type: none"> <li>&gt; independent height / tilt changing</li> <li>&gt; real height related tilt changing (configurable)</li> <li>&gt; optional longitudinal compensation</li> </ul>	
Control cable		fiber optic (polymer type)	
Drive unit		shielded and radio interference suppressed 20 dB under Class B of CISPR 22	
Operating voltage		230 V 50 / 60 Hz (optional 110 V)	
Current consumption		max. 2.2 A	
Temperature range		+8 °C...+40 °C	

<sup>1</sup> Height of antennas reference point for a distance of 900 mm from mast tube (pole)





## | 2.7 | ANTENNA MASTS (MA-XP-ET-0800)

The MA-XP-ET-0800 antenna masts are compliant with CISPR 16-1-4 BORESIGHT requirements. Metal parts are located only in the base plate and the drive mechanism (max. 0.4 m above ground level). Limit switches and the general mechanical design provide a safe system operation.

The separate controlled motors support simultaneous movement with both independent changing of height and tilt and also an automatic but configurable link of both values. (tilt while height change).

The GPIB (IEEE 488) & LAN (TCP/IP) bus, when operated with the CO 3000 Controller, provides an additional control option for all functions.

ANTENNA MASTS (MA-XP-ET-0800)		
Type	Description	Article No.
MA4640-XP-ET-0800	Electric height adjustment 1000...4000 mm (tilted), 800...4640 mm (not tilted), max. load 10 kg XP = Pneumatic Polarisation by internal compressor (no compressed air needed) ET = Electric Tilt adjustment	80007055
MA6000-XP-ET-0800	Electric height adjustment 1000...5400 mm (tilted), 800...6000 mm (not tilted), max. load 10 kg	80007149

ACCESSORIES		
Type	Description	Article No.
-O	OATS version for MA series	80000331
-MT	Optional manual tilt bore sight (only with -PP or -XP)	80000337
-HK	Hand crank for height adjustment (without drive unit)	80004907
-15kg	Max. antenna load up to 15 kg incl. CW5	80004908
-HS	Max. antenna mast speed up to 25 cm/s	80005564
-CISPR16	Antenna rod extend to 2000 mm	80005111
-PR 7/16	Polarisation rod for 7/16 antenna connector	80600029

SCOPE OF DELIVERY	
Type	Quantity
Interface to CO 3000	2 x
Power supply cable	1 x 5 m
Fiber optic cable	4 x 5 m, 2 x 10 m
FSMA	8 x
Polarisation rod shifttable	450 mm
Operating manual	1 x

TECHNICAL DATA			
TYPE		MA 4640-XP-ET-0800	MA 6000-XP-ET-0800
Antenna height (horizontal)	tilted	1000 ... 4000 mm <sup>1</sup>	1000 ... 5400 mm
	not tilted	800 ... 4640 mm	800 ... 6000 mm
Total mast height		max. 5200 mm	max. 6600 mm
Antenna weight		max. 10 kg	
Material		PVC + RFP, weatherproof	
Mast cross-section		100 mm x 100 mm	
Base L x W		1080 mm x 1080 mm	
Positioning speed adjustable		1 ... 12 cm / sec (15 or 20 cm / sec available)	
Positioning accuracy		better ± 3 mm	
Pneumatic polarisation		0° / 90° (vert. / hor.)	
Positioning time 0° / 90°		approx. 4 sec	
Polarisation accuracy		better ± 0.1°	
Air pressure needed		none (internal DC compressor)	
Tilt angle		-12°...45°	
Tilt speed		7.5 ° / sec	
Tilt accuracy		better ± 0.5°	
Antenna support drive		2 toothed belts (Kevlar® cord reinforced)	
Motor		2 electronic EC motors (max. 150 W) separate controlled for simultaneous movements	
Control		microcontroller	
Control modes supported in CO 3000 controller		<ul style="list-style-type: none"> <li>&gt; independent height / tilt changing</li> <li>&gt; real height related tilt changing (configurable)</li> <li>&gt; optional longitudinal compensation</li> </ul>	
Control cable		fiber optic (polymer type)	
Drive unit		shielded and radio interference suppressed 20 dB under Class B of CISPR 22	
Operating voltage		230 V 50 / 60 Hz (optional 110 V)	
Current consumption		max. 2.2 A	
Temperature range		+8 °C...+40 °C	

<sup>1</sup> Height of antennas reference point for a distance of 900 mm from mast tube (pole)





## | 2.8 | TWIN MASTS WITH ELECTRICAL POLARISATION (TW-EP)

The TW-EP antenna masts are suitable for use in either open areas or in electromagnetic absorption chambers. Metal parts are located only in the base plate and the drive mechanism (max. 0.4 m above ground level).

Adapters for all commercially available antennas are available. Special designs on request. All antennas during polarisation rotate around their axis so as to eliminate any elevation errors. Limit switches and the general mechanical design ensures a reliable system operation.

The GPIB (IEEE 488) & LAN (TCP/IP) bus, when operated with the CO 3000 Controller, provides an additional control option for all functions.

### TWIN MASTS WITH ELECTRICAL POLARISATION (TW-EP)

Type	Description	Article No.
TW 4000-EP	Electric height adjustment 1000...4000 mm, max. load 20 kg EP = Electrical Polarisation,	80000076
TW 6000-EP	Electric height adjustment 1000...6000 mm, max. load 20 kg	80005545
TW 10000-EP-OATS	Electric height adjustment 1000...10000 mm, max. load 20 kg	80600005

### ACCESSORIES

Type	Description	Article No.
-HS	Max. antenna mast speed up to 25 cm/s	80005233
-XP	Integrated compressor for TW-PP	80002537
-CISPR16	Antenna rod extend to 2000 mm	80005111
-PR 7/16	Polarisation rod for 7/16 antenna connector	80600029

### SCOPE OF DELIVERY

Type	Quantity
Interface to CO 3000	1 x
Power supply cable	1 x 5 m
Fiber optic cable	2 x 5 m, 1 x 10 m
Fiber optic cable TW 10000-EP-OATS	1 x 10 m, 1 x 20 m
FSMA	4 x
FSMA TW 10000-EP-OATS	2 x
Polarisation rod shiftable	450 mm
Operating manual	1 x

TECHNICAL DATA			
TYPE	TW 4000-EP	TW 6000-EP	TW 10000-EP-OATS
Antenna height	1000...4000 mm	1000...6000 mm	1000...10000 mm
Total mast height	max. 4600 mm	max. 6600 mm	max. 10600 mm
Material	PVC + GFK, weatherproof		
Mast cross-section	(2 x) 100 mm x 100 mm		
Base L x W	1200 mm x 1000 mm	1200 mm x 1000 mm	1410 mm x 1280 mm
Antenna weight	max. 20 kg (25 kg available)		
Positioning speed adjustable	4 ... 14 cm / sec (20 or 25 cm / sec available)		
Positioning accuracy	better $\pm$ 5 mm		
Polarisation electric	0° / 90° (vert. / hor.)		
Positioning time 0° / 90°	approx. 4 sec		
Polarisation accuracy	$\pm$ 0.5°		
Antenna support drive	3 toothed belts (Kevlar® cord reinforced)		
Motor	electronic EC motor 300 W		
Control cable	fiber optic (polymer type)		
Control	microcontroller by fiber optic (polymer type)		
Drive unit	shielded and radio interference suppressed 20 dB under Class B	shielded and radio interference suppressed 20 dB under Class B	shielded and radio interference suppressed 20 dB under Class B & for Open Area Test Site sealed
Operating voltage	230 V 50 / 60 Hz (optional 110 V)		
Current consumption	max. 3.2 A		
Temperature range	+8 °C...+40 °C	+8 °C...+40 °C	-5 °C...+40 °C





## | 2.9 | TWIN MASTS WITH PNEUMATIC POLARISATION (TW-PP)

The TW-PP antenna masts are suitable for use in either open areas or in electromagnetic absorption chambers. Metal parts are located only in the base plate and the drive mechanism (max. 0.4 m above ground level).

Adapters for all commercially available antennas are available. Special designs on request. All antennas during polarisation rotate around their axis so as to eliminate any elevation errors. Limit switches and the general mechanical design ensures a reliable system operation.

The GPIB (IEEE 488) & LAN (TCP/IP) bus, when operated with the CO 3000 Controller, provides an additional control option for all functions.

TWIN MASTS WITH PNEUMATIC POLARISATION (TW-PP)		
Type	Description	Article No.
TW 4000-PP-ET	Electric height adjustment 1000...4000 mm, max. load 15 kg PP = Pneumatic Polarisation ET = Electric Tilt adjustment	80005683
TW 6000-PP-ET	Electric height adjustment 1000...6000 mm, max. load 15 kg	80000339
TW 10000-PP-OATS	Electric height adjustment 1000...10000 mm, max. load 20 kg	80000999

ACCESSORIES		
Type	Description	Article No.
-HS	Max. antenna mast speed up to 25 cm/s	80005233
-XP	Integrated compressor for TW-PP	80002537
-CISPR16	Antenna rod extend to 2000 mm	80005111
-PR 7/16	Polarisation rod for 7/16 antenna connector	80600029

SCOPE OF DELIVERY	
Type	Quantity
Interface to CO 3000	1 x
Power supply cable	1 x 5 m
Fiber optic cable	2 x 5 m, 1 x 10 m
Fiber optic cable TW 10000-PP-OATS	1 x 10 m, 1 x 20 m
FSMA	4 x
FSMA TW 10000-PP-OATS	2 x
Pneumatic tube	1 x 12.5m
Pneumatic wall-panel bulkhead fitting	1 x
Pressure reducing valve	1 x
Polarisation rod shiftable	450 mm
Operating manual	1 x



TECHNICAL DATA			
TYPE	TW 4000-PP-ET	TW 6000-PP-ET	TW 10000-PP-OATS <sup>1</sup>
Antenna height	1000...4000 mm	1000...6000 mm	1000...10000 mm
Total mast height	max. 4600 mm	max. 6600 mm	max. 10600 mm
Material	PVC + GFK, weatherproof		
Mast cross-section	(2 x) 100 mm x 100 mm		
Base L x W	1200 mm x 1000 mm	1200 mm x 1000 mm	1410 mm x 1280 mm
Antenna weight	max. 15 kg (25 kg available)	max. 15 kg (25 kg available)	max. 20 kg
Positioning speed adjustable	4...14 cm / sec (20 or 25 cm / sec available)		
Positioning accuracy	better ± 5 mm		
Polarisation pneumatic	0° / 90° (vert. / hor.)		
Polarisation drive	pneumatic rotation cylinder		
Tilt angle	0° to 45° (in 1° steps adjustable)	0° to 45° (in 1° steps adjustable)	–
Tilt speed	1° / sec	1° / sec	–
Tilt accuracy	± 0.5°	± 0.5°	–
Positioning time 0° / 90°	approx. 4 sec		
Polarisation accuracy	better ± 0.5°		
Antenna support drive	2 toothed belts (Kevlar® cord reinforced)	3 toothed belts (Kevlar® cord reinforced)	2 toothed belts (Kevlar® cord reinforced)
Motor	electronic EC motor 300 W		
Control cable	fiber optic (polymer type)		
Control	microcontroller by fiber optic line		
Drive unit	shielded and radio in- terference suppressed 20 dB under Class B	shielded and radio in- terference suppressed 20 dB under Class B	shielded and radio in- terference suppressed 20 dB under Class B & for Open Area Test Site sealed
Pressure	min. 6 bar		
Operating voltage	230 V 50 / 60 Hz (optional 110 V)		
Current consumption	max. 3.2 A		
Temperature range	+8 °C...+40 °C	+8 °C...+40 °C	-5 °C...+40 °C

<sup>1</sup> OATS accessories: guy wires; integrated, temperature controlled heater; rain protection cover; stainless steel support; sealed drive unit





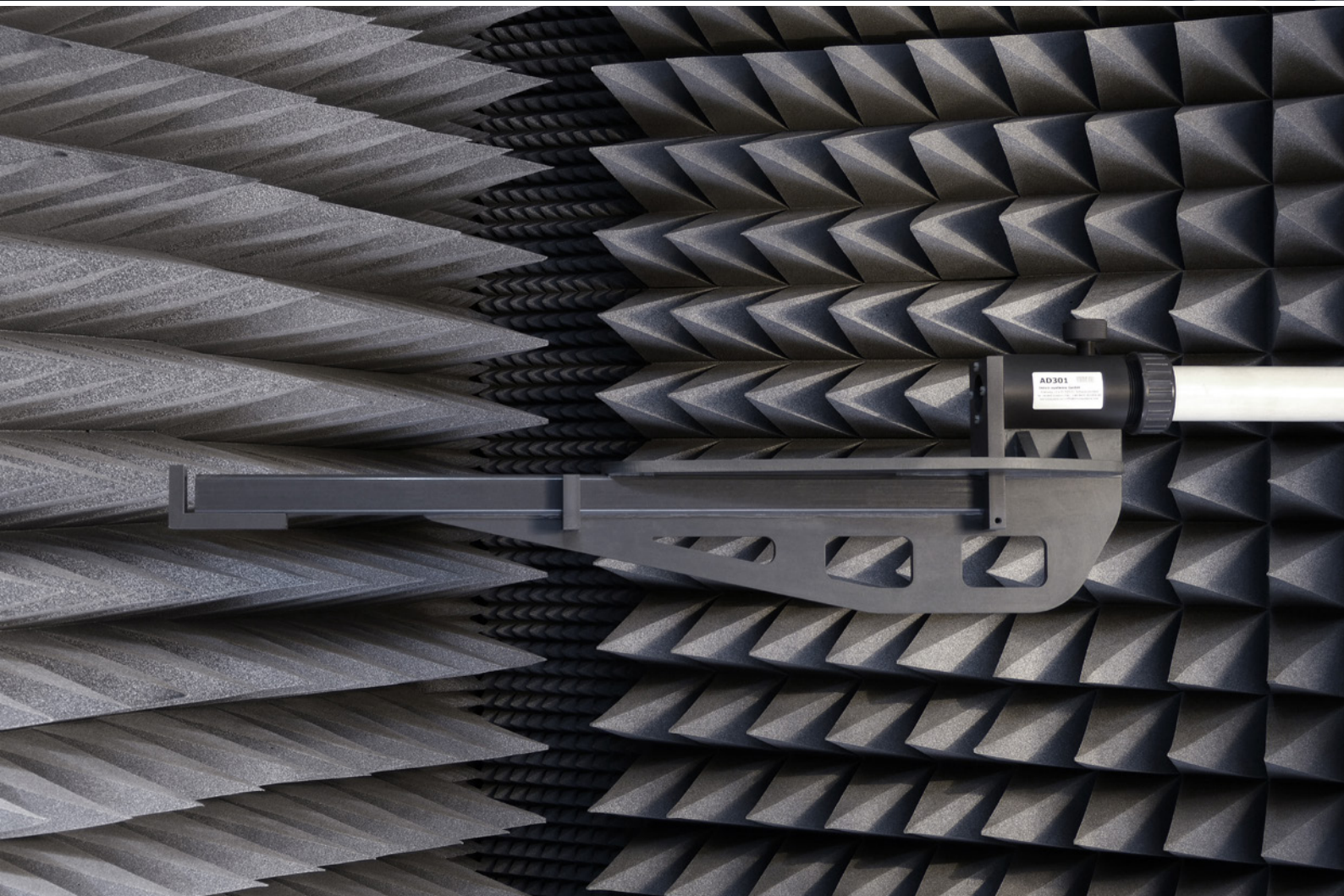
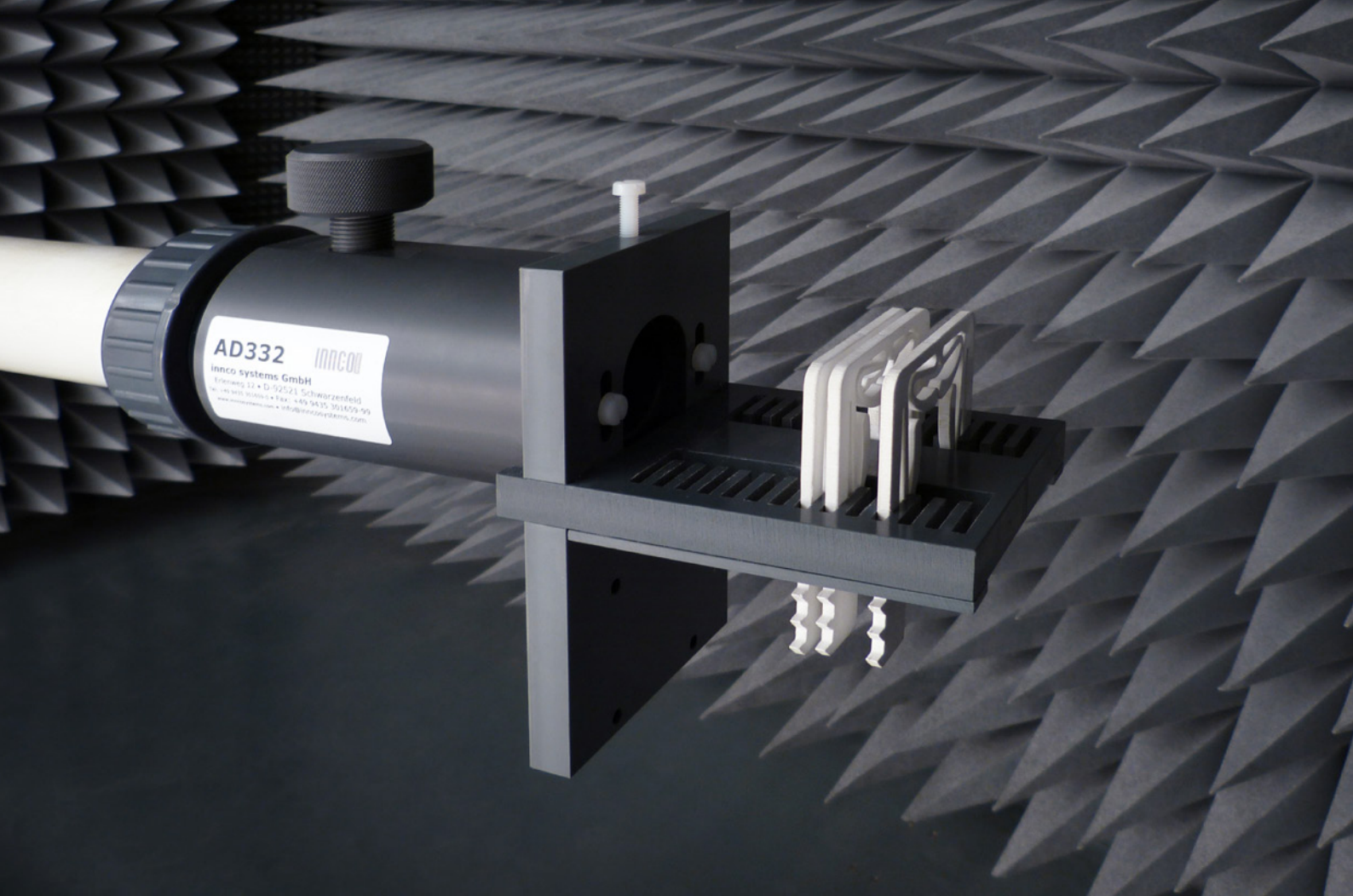





## | 3.1 | PRODUCT OVERVIEW

innco systems antenna adapters for all standard antennas are available. Nonstandard are also available upon request. The adapter materials are designed to provide stability, with the lowest possible weight.

Adapters are compatible with HD-GmbH (Heinrich Deisel), Innco GmbH and innco systems GmbH antenna masts.

ANTENNA ADAPTERS		
Type	Antenna	Article No.
<b>Rohde &amp; Schwarz</b>		
AD 210	HF 906, HF 907, HL 023, HL 040, HL 562, HK 116	80000091
AD 211	HL 223	80000092
AD 212	HL 025, HL 050	80000093
AD 212 f. DE3600RH	HL 050	80000093
AD 238	HE 202	80000094
AD 266	HE 526 - HE 527	80000116
AD 315	HFH2-2Z	80006667
AD 326	like AD 211, but for polarisation rod Ø 40.1 mm	On request
<b>Schwarzbeck</b>		
AD 213	all common models, VULB9160, VULB 9168, VULB 9163 UHALP 9108A, VHBB 9124, VUSLP 9111, VHAP, UHAP, STLP 9128 C	80000095
AD 222	VULP 9118 C-H	80000096
AD 236	BBHA 9170	80000097
AD 245	BBHA 9120 D (replaced by AD283)	80000098
AD 259	VHBD 9134- BBFA 9146	80000123
AD 278	STLP 9128 E	80004853
AD 281	STLP 9128 E designed for special mast	80005684
AD 283	like AD 213, just longer and with cable entry, BBHA 9120D & E	80005013
AD 284	like AD 213, just shorter (170 mm total)	80005025
AD 285	like AD 283, just shorter (270 mm total)	80005082
AD 287	like AD 213, just shorter (200 mm total)	On request
AD 295	like AD 213 as 2-part version for 7/16-connector	80005292
AD 333	Horn-antenna STLP9120J (7,6kg)	80006982
<b>Schaffner-Chase</b>		
AD 213	CBL 6111, CBL 6112, CBL 6141, CBL 6143A-E, CBL 6111A-D	80000095
AD 227	CBL 6121	80000099
AD 228	CBL 6140, CBL 6140A, CBL 6144	80000100
AD 263	CBL 6112 B / clamped design	80004857

<b>EMCO / ETS Lindgren</b>		
AD 214	3104 C / 3121 C	80000101
AD 215	3108	80000102
AD 216	3109	80000103
AD 217	3110	80000104
AD 218	3115, 3117	80000105
AD 219	3142D, 3149	80000107
AD 316	3149D, 3142E & 3142C	80006708
AD 220	3143	80000108
AD 221	3146	80000109
AD 223	3148	80000110
AD 231	3141	80000111
AD 241	3161-01	80000112
AD 243	3160-3	80000113
AD 251	3116 & 3116C	80000106
AD 262	3144	80005084
AD 273	3160-09	On request
AD 274	3164-03, 3164-06, 3164-08	80005088
AD 275	3106	80000333
AD 323	3106	80006830
<b>Amplifier Research</b>		
AD 224	AT 1000, AT 1080	80000114
AD 225	AT 110	80000115
AD 226	AT 4002, AT4510, AT 4002 A für MA	80000116
AD 252	AT 4003	80000117
AD 253	AT 4004	80000118
AD 264	AT 4002 A for field probe positioner (FSM)	80005085
AD 288	AT 4218	80006658
<b>Electro Metrics</b>		
AD 230	RGA 60	80000119
AD 235	LCA 30	80000120
AD 237	BIA 25	80000121
AD 238	RGA 180	80000094
AD 301	Electro-Metrics EM-6917C-1	80005666
<b>Frankonia</b>		
AD 233	BTA-H / L	80000122
AD 258	BTA-M (old Version until 13.6.2008)	80000131
AD 328	Antenna flange ø 80 mm (BTA-M new version from 13.6.2008)	80000479
<b>Eaton</b>		
AD 234	93491-2	80000124

Accessories		
CW5	5 kg counterweight for antenna mast, if large antennas are used	80000135
CW7	7 kg counterweight for antenna mast, if large antennas are used	80000399
Rolf Heine GmbH		
AD 239	HA 17	80000125
AD 240	SCH 1	80000126
AD 246	SCH 2	80000127
AD 248	SCH 3	80000128
AD 249	SCH 4	80000129
Seibersdorf		
AD 242	PBA 10200, PCD	80000130
AD329	PCD3100, PCD8250	80006835
AD330	PRD-H (reference dipol)	80006836
TDK USA (EMCA)		
AD 213	MBA 2060	80000095
AD 289	LPDA 0803	80005244
AD 214	PBA 2030	80000101
AD 244	HLP 3003 C	80000132
AD 247	PLP 3003	80000133
AD 218	HRN 0118	80000105
A.H. Systems		
AD 210	SAS-521-2	80000091
AD 257	SAS-200/512 F, SAS-521-4	80000134
AD 280	SAS-571	80004854
AD 303	SAS-521-2, SAS-521-4, SAS-521-7	80005754
Antenna Research		
AD 257	DRG-118 / A	80000134
Sunol Sciences		
AD 265	JB1-5 Series	80004847
IFI		
AD 267	LP 2000	80005087
Others		
AD 260	BLA 3000	80005083
AD 297	for microwave antennas with $\varnothing$ 22 mm rod (e.g. Schwarzbeck SBA9113 with 420NJ element) adjustment range $\pm$ 500 mm	80005562
AD 298	clampable for all antennas with $\varnothing$ 22 mm rod	80005798
AD 299	to reduce measurement height 200 mm $\pm$ 50 mm, with 1/4" UNC fixing screw	80001299
AD 304	for all models to clamp 25 mm antenna rod	80005755
AD 305	for all models to clamp 30 mm antenna rod	80005756



AD 306	for all models to clamp 42 mm antenna rod	80005757
AD 311	for Aaronia nearfield-probe up to 6 GHz	80006640
AD 331	for loop-antenna with 3/8" fixing thread on bottom (e.g. HFRA 5149)	80006971
AD 332	universal adapter for small horn antennas (e.g. ETS 3160-09, 3160-10)	80006974
AD 334	like AD298, with longhole for cable entrance (if horn antenna is used)	80005890
AD 340	horn antenna with 1/4"-20, height adjustment from 40...60 mm	80007081
AD 341	horn antenna with 1/4"-20, height adjustment from 25...45 mm	80007098
AD 343	standard gain horn antenna LB-42-25 (A-Info)	On request
AD 344	broadband horn antenna LB-20180-H (A-Info)	On request
<b>Adapter-Extension / Accessories</b>		
AD 276	polarisation rod extension 400 mm	80005089
AD 286	polarisation rod extension 1300 mm	80006989
AD342	adapter for +200 or -200 mm height difference	On request





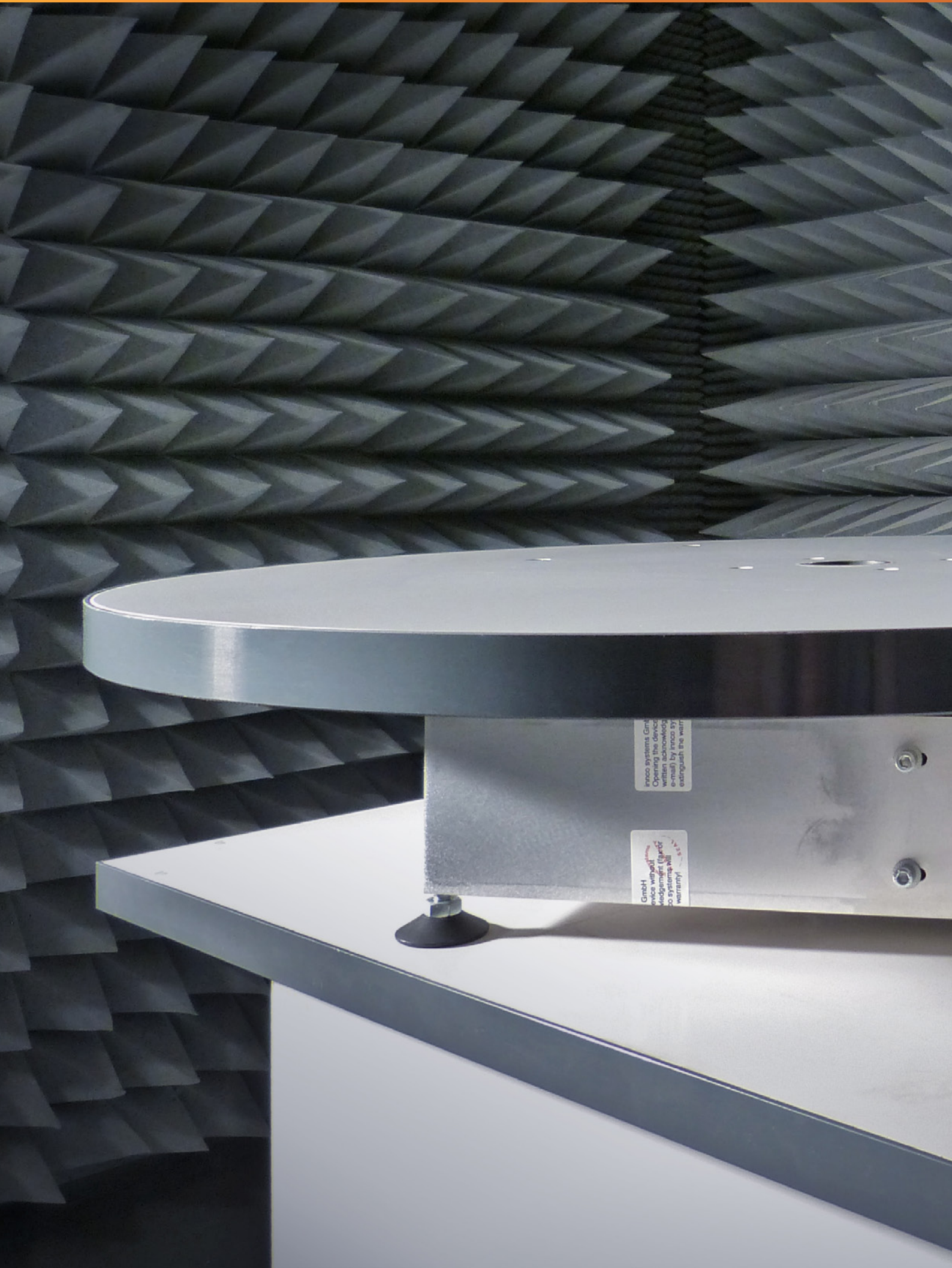

## | 4 | TURNTABLES

innco systems turntables are designed to be installed for surface mounting, free space environments or integrated, as part of a raised ground plane floor system. innco systems have designs for both inside EMC chambers or as part of an Open Area Test Site (OATS). The turntable top cover plates are available in plastic, sealed multilayer wood or stainless steel.

The turntable connection panel (CP) can be mounted in the center or at a position to be agreed. Standard power supplies, connectors or custom specific supplies can be provided, which can also include cable management systems (energy chain).

High performance electric continuity in ground plane floors during rotation is achieved using a proven copper connection system.

Our solutions provide optimized EMC performances, using specially design shielded drive units, which provide our turntable systems with the required 20 dB below the limit line of CISPR 12 and CISPR 22.

### COMPACT (CT)

- Top plate made of PVC
- 500...1000 mm diameter
- 75 kg...150 kg load



### COMPACT – HEIGHT ADJUSTABLE (CTE)

- Top plate made of PVC
- 500 mm diameter
- 25 kg load
- 700 mm...1100 mm height extendable





## | 4.1 | PRODUCT OVERVIEW

### PVC (KT)

- Top plate made of PVC
- 1200...1500 mm diameter
- 100 kg load



### LOW PROFILE – FREE STANDING WITH WOODEN PLATE (DS-HA)

- Top plate made of wood
- 1000...2000 mm diameter
- 200 kg...500 kg load

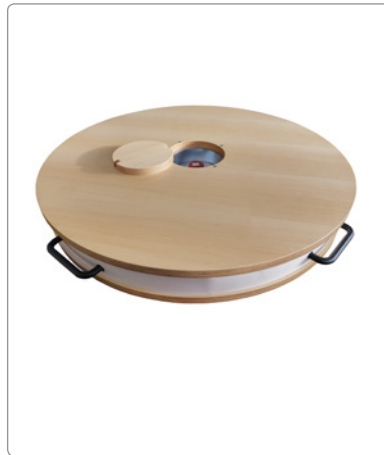

### LOW PROFILE – WOODEN COVER (DS-HE)

- Top plate made of wood
- 1200...2000 mm diameter
- 500 kg load

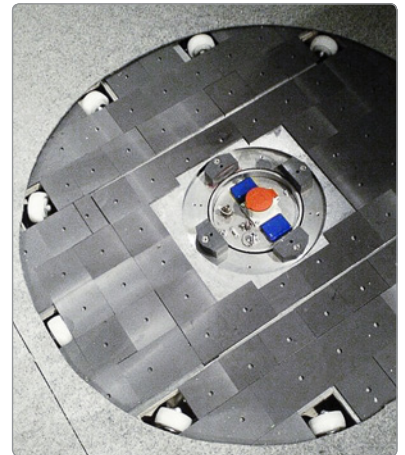

### LOW PROFILE – STAINLESS STEEL COVER (DS-S)

- Top plate made of stainless steel
- 1200...2000 mm diameter
- 500 kg...1000 kg load



### HIGH LOAD – STAINLESS STEEL COVER (DT)

- Top plate made of stainless steel
- 2000...20000 mm diameter
- 2000 kg...100000 kg load



### HIGH LOAD DUAL – STAINLESS STEEL COVER (DDT)

- Top plate made of stainless steel
- 3000...10000 mm diameter
- 3000 kg...10000 kg load





## | 4.2 | COMPACT (CT)

The CT is a compact and inexpensive turntable for test objects up to 150 kg. The CT is dismantlable and easy to transport. The options for the automatic control are the controller CO 3000 or directly a PC via RS232 or USB.

If ordered with PC Control, the CT will be delivered with small demo software written in Virtual Basic, C++ or LabView.

The GPIB (IEEE 488) & LAN (TCP/IP) bus, when operated with the CO 3000 Controller, provides an additional control option for all functions.

### COMPACT TURNTABLES (CT)

Type	Description	Article No.
CT 0500	Ø 500 mm, height 188 mm, max. load 75 kg	80005764
CT 0800	Ø 800 mm, height 188 mm, max. load 75 kg	80000138
CT 1000	Ø 1000 mm, height 188 mm, max. load 150 kg	80000296

### ACCESSORIES

Type	Description	Article No.
-HP	High precision positioning (0.1 angular degree)	80004873
-ER	Endless turning (permanent positioning)	80004875
-150kg	150 kg load capacity for turntable CT series	80004880
-MV	Movable version with wheels instead of stands	80500059

### SCOPE OF DELIVERY

Type	Quantity
Interface to CO 3000	1 x
Power supply cable	1 x 5 m
Fiber optic cable	1 x 5 m, 1 x 10 m
FSMA	2 x
Operating manual	1 x



TECHNICAL DATA			
TYPE	CT 0500	CT 0800	CT 1000
Diameter	500 mm	800 mm	1000 mm
Permissible load	max. 75 kg	max. 75 kg	max. 150 kg
Height	188 mm		
Material carrier plate	Kömacel®, PVC-border-ring, weatherproof or wood		
Rotating time adjustable between	0.5...2.0 rpm		
Positioning accuracy	better $\pm 1^\circ$		
Rotating angle	-200...+400° or endless / continuous		
Control cable	fiber optic (polymer type)		
Motor	electronic EC motor 150 W		
Drive unit	shielded and radio interference suppressed 20 dB under Class B		
Operating voltage	110 / 230 V (50 / 60 Hz)		
Current consumption	max. 1.6 A		
Temperature range	+8 °C...+40 °C		





### | 4.3 | COMPACT – HEIGHT ADJUSTABLE (CTE)

The CTE is an inexpensive compact table with non-metallic plate which is height adjustable in a certain range. The clamping mechanism does not require any tools to adjust the height.

In the center of the carrier plate a  $\varnothing$  45 mm hole gives the possibility to route cables to the EUT through the tubes and the drive which pursues this duct down to the floor. The  $\varnothing$  45mm allows to route typical CEE7/... and common NEMA household plugs if the plugs are straight.

The drive cover of the allows to place ferrites or absorbers easily on the drive unit.

The GPIB (IEEE 488) & LAN (TCP/IP) bus, when operated with the CO 3000 Controller, provides an additional control option for all functions.

#### COMPACT TURNTABLE – HEIGHT ADJUSTABLE (CTE)

Type	Description	Article No.
CTE 0500	$\varnothing$ 500 mm, height adjustable 700...1100 mm, max. load 25 kg	80005164

#### ACCESSORIES

Type	Description	Article No.
-HP	High precision positioning (0.1 angular degree)	80004873
-ER	Endless turning (permanent positioning)	80004875
-MV	Movable version with wheels instead of stands	80500059

#### SCOPE OF DELIVERY

Type	Quantity
Interface to CO 3000	1 x
Power supply cable	1 x 5 m
Fiber optic cable	1 x 5 m, 1 x 10 m
FSMA	2 x
Operating manual	1 x

TECHNICAL DATA

TYPE	CTE 0500
Diameter	500 mm
Permissible load	25 kg
Height adjustable between	700...1100 mm (others on request)
Material carrier plate	Kömacel®, PVC-border-ring
Rotating time adjustable between	0.5...2.0 rpm
Positioning accuracy	± 0.3 °
Rotating angle	-200...+400 ° or endless / continuous
Control	microcontroller board
Control cable	fiber optic (polymer type)
Motor	electronic EC motor 150 W
Drive unit	shielded and radio interference suppressed max. 5 dB over the background noise
Operating voltage	110 / 230 V (50 / 60 Hz)
Current consumption	max. 1.6 A
Temperature range	+8 °C...+40 °C





### | 4.4 | PVC (KT)

The KT turntables with the exception of the drive unit are fabricated totally from plastic (PVC). A 145 mm diameter opening in the centre of the turntable provides the capability to insert a power supply for testing. Three (3) supplied insertable shafts enable cables to be laid up to 1.5 meters from the turntable centre.

The GPIB (IEEE 488) & LAN (TCP/IP) bus, when operated with the CO 3000 Controller, provides an additional control option for all functions.

#### PVC TURNTABLES (KT)

Type	Description	Article No.
KT 1200	Ø 1200 mm, height 800 mm, max. load 100 kg	80004881
KT 1500	Ø 1500 mm, height 800 mm, max. load 100 kg	80004882

#### ACCESSORIES

Type	Description	Article No.
-HP	High precision positioning (0.1 angular degree)	80004873
-ER	Endless turning (permanent positioning)	80004875
-3rpm	Maximal speed up to 3 rpm	80004877

#### SCOPE OF DELIVERY

Type	Quantity
Interface to CO 3000	1 x
Power supply cable	1 x 5 m
Fiber optic cable	1 x 5 m, 1 x 10 m
FSMA	2 x
Operating manual	1 x

TECHNICAL DATA		
TYPE	KT 1200	KT 1500
Diameter	1200 mm	1500 mm
Permissible load	max. 100 kg	
Height	800 mm	
Material carrier plate	PVC, weatherproof	
Rotating time adjustable between	0.5...2.0 rpm	
Positioning accuracy	± 0.5 °	
Rotating angle	-200...+400 °	
Control	microcontroller	
Control cable	duplex fiber optic (polymer type)	
Turntable drive	bevel/crown wheel pairing	
Motor	electronic EC motor 150 W	
Drive unit	shielded and radio interference suppressed	
Operating voltage	110 / 230 V (50 / 60 Hz)	
Current consumption	max. 1.6 A	
Temperature range	+8 °C...+40 °C	



## | 4.5 | LOW PROFILE – FREE STANDING WITH WOODEN PLATE (DS-HA)

The DS-HA turntables are specifically designed for installation either at intermediate levels in electromagnetic absorption chambers or in open areas. The base plate is available in waterproof, laminated and lacquered wood (0.03 m thickness)

A 20 cm diameter opening in the centre of the turntable provides the capability to insert a power supply for testing.

The GPIB (IEEE 488) & LAN (TCP/IP) bus, when operated with the CO 3000 Controller, provides an additional control option for all functions.

### LOW PROFILE TURNTABLES – FREE STANDING WITH WOODEN PLATE (DS-HA)

Type	Description	Article No.
DS 1000-HA	Ø 1000 mm, height 156 mm, load 200 kg	80000146
DS 1200-HA	Ø 1200 mm, height 156 mm, load 300 kg	80000147
DS 1500-HA	Ø 1500 mm, height 156 mm, load 500 kg	80000148
DS 2000-HA	Ø 2000 mm, height 166 mm, load 500 kg	80000149

### ACCESSORIES

Type	Description	Article No.
-HP	High precision positioning (0.1 angular degree)	80004873
-O	OATS kit for DSXX00-HA series	80004874
-ER	Endless turning (permanent positioning)	80004875
-kg	Higher capacity for turntable DS-HA series	80004876
-3rpm	Maximal speed up to 3rpm	80004877

### SCOPE OF DELIVERY

Type	Quantity
Interface to CO 3000	1 x
Power supply cable	1 x 3 m
Fiber optic cable	1 x 5 m, 1 x 10 m
FSMA	2 x
Standard CP	1 x
Operating manual	1 x



TECHNICAL DATA			
TYPE	DS 1000-HA	DS 1200-HA	DS 1500-HA
Diameter	1000 mm	1200 mm	1500 mm
Permissible load	max. 200 kg	max. 300 kg	max. 500 kg
Height	156 mm		
Material carrier plate	wood		
Rotating time adjustable between	0.5...2.0 rpm		
Positioning accuracy	better $\pm 1^\circ$		
Rotating angle	-200...+400°		
Control	microcontroller		
Control cable	fiber optic (polymer type)		
Turntable drive	chain drive, worm gear		
Motor	electronic EC motor 150 W		
Drive unit	shielded and radio interference suppressed 20 dB under Class B		
Operating voltage	230 V 50 / 60 Hz (optional 110 V)		
Current consumption	max. 1.6 A		
Temperature range	+8 °C...+40 °C		
TYPE	DS 2000-HA		
Diameter	2000 mm		
Permissible load	max. 500 kg		
Height	166 mm		
Material carrier plate	wood		
Rotating time adjustable between	0.5...2.0 rpm		
Positioning accuracy	better $\pm 1^\circ$		
Rotating angle	-200...+400°		
Control	microcontroller		
Control cable	fiber optic (polymer type)		
Turntable drive	chain drive, worm gear		
Motor	electronic EC motor 150 W		
Drive unit	shielded and radio interference suppressed 20 dB under Class B		
Operating voltage	230 V 50 / 60 Hz (optional 110 V)		
Current consumption	max. 1.6 A		
Temperature range	+8 °C...+40 °C		

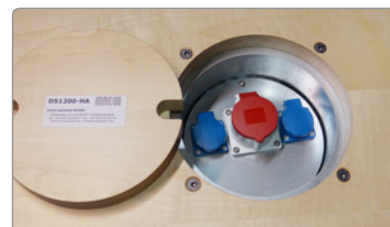

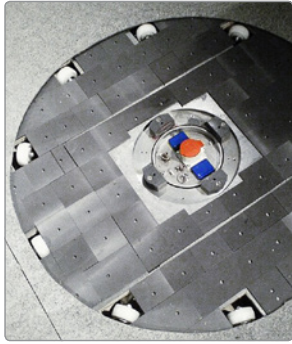

## | 4.6 | LOW PROFILE – WOODEN COVER (DS-HE)

The DS-HE turntables are specifically designed for installation at intermediate levels in electromagnetic absorption chambers.

A 0.2 m diameter opening in the centre of the turntable provides the capability to insert a power supply for testing. Removable braces can be installed if necessary.

The GPIB (IEEE 488) & LAN (TCP/IP) bus, when operated with the CO 3000 Controller, provides an additional control option for all functions.

### LOW PROFILE TURNTABLES – WOODEN COVER (DS-HE)

Type	Description	Article No.
DS 1200-HE	Ø 1200 mm, height 166 mm, load 300 kg	80000150
DS 1500-HE	Ø 1500 mm, height 166 mm, load 500 kg	80000151
DS 2000-HE	Ø 2000 mm, height 166 mm, load 500 kg	80000152

### ACCESSORIES

Type	Description	Article No.
-HP High	Precision positioning (0.1 angular degree)	80004873
-ER	Endless turning (permanent positioning)	80004875
-kg	Higher capacity for turntable DS-HE series	80004876
-3rpm	Maximal speed up to 3rpm	80004877

### SCOPE OF DELIVERY

Type	Quantity
Interface to CO 3000	1 x
Power supply cable	1 x 3 m
Fiber optic cable	1 x 5 m, 1 x 10 m
FSMA	2 x
Standard CP	1 x
Operating manual	1 x

TECHNICAL DATA			
TYPE	DS 1200-HE	DS 1500-HE	DS 2000-HE
Diameter	1200 mm	1500 mm	2000 mm
Permissible load	max. 300 kg	max. 500 kg	max. 500 k
Height	166 mm		
Material carrier plate	wood		
Rotating time adjustable between	0.5...2.0 rpm		
Positioning accuracy	better $\pm 1^\circ$		
Rotating angle	-200...+400°		
Control	microcontroller		
Control cable	fiber optic (polymer type)		
Turntable drive	chain drive, worm gear		
Motor	electronic EC motor 150 W		
Drive unit	shielded and radio interference suppressed 20 dB under Class B		
Operating voltage	230 V 50 / 60 Hz (optional 110 V)		
Current consumption	max. 1.6 A		
Temperature range	+8 °C...+40 °C		

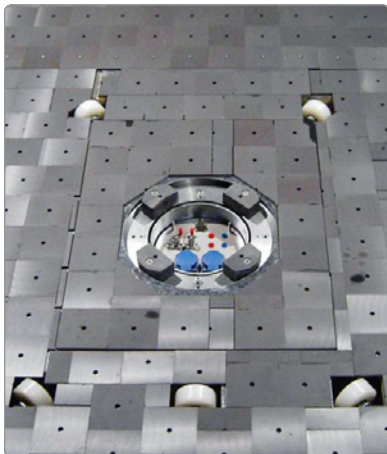



## | 4.7 | LOW PROFILE – STAINLESS STEEL COVER (DS-S)

The DS-S turntables are specifically designed for installation either at intermediate levels in electromagnetic absorption chambers or in open areas. The base plate is available in stainless steel.

If a ground plane exists, and the carrying plate is made of steel, then the adapter contact ring with a quadratic rim can be supplied. A 0.2 m diameter opening in the centre of the turntable provides the capability to insert a power supply for testing. Removable braces can be installed if necessary.

The GPIB (IEEE 488) & LAN (TCP/IP) bus, when operated with the CO 3000 Controller, provides an additional control option for all functions.

### LOW PROFILE TURNTABLES – STAINLESS STEEL COVER (DS-S)

Type	Description	Article No.
DS 1200-S	Ø 1200 mm, height 130 mm, load 500 kg	80000153
DS 1500-S	Ø 1500 mm, height 130 mm, load 500 kg	80000339
DS 2000-S	Ø 2000 mm, height 141 mm, load 750 kg	80000155
DS 3000-S	Ø 3000 mm, height 180 mm, load 500 kg	80007158

### ACCESSORIES

Type	Description	Article No.
-HP High	Precision positioning (0.1 angular degree)	80004873
-O	OATS kit for DS-S series	80004874
-ER	Endless turning (permanent positioning)	80004875
-kg	Higher capacity for turntable DS-S series	80004876
-3rpm	Maximal speed up to 3rpm	80004877

### SCOPE OF DELIVERY

Type	Quantity
Interface to CO 3000	1 x
Power supply cable	1 x 3 m
Fiber optic cable	1 x 5 m, 1 x 10 m
FSMA	2 x
Standard CP	1 x
Operating manual	1 x

TECHNICAL DATA			
TYPE	DS 1200-S	DS 1500-S	DS 2000-S
Diameter	1200 mm	1500 mm	2000 mm
Permissible load	500 kg	500 kg	750 kg
Height	min. 130 mm	min. 130 mm	min. 141 mm
Material	stainless steel		
Base L x W	1500 x 1500 mm	1800 x 1800 mm	2300 x 2300 mm
Positioning time adjustable between	0.5...2.0 rpm		
Positioning accuracy	better $\pm 1^\circ$	better $\pm 1^\circ (\pm 0.5^\circ)$	better $\pm 1^\circ (\pm 0.3^\circ)$
Rotating angle	-200...+400°		
Control	microcontroller		
Control cable	fiber optic (polymer type)		
Turntable drive	chain drive, worm gear		
Motor	electronic EC motor 150 W		
Drive unit	shielded and radio interference suppressed 20 dB under Class B		
Operating voltage	230 V 50 / 60 Hz (optional 110 V)		
Current consumption	max. 1.6 A		
Temperature range	+8 °C...+40 °C		
TYPE	DS 3000-S		
Diameter	3000 mm		
Permissible load	500 kg		
Height	min. 180 mm		
Material	stainless steel		
Base L x W	3300 x 3300 mm		
Positioning time adjustable between	0.3...1.0 rpm		
Positioning accuracy	better $\pm 1^\circ$		
Rotating angle	-200...+400°		
Control	microcontroller		
Control cable	fiber optic (polymer type)		
Turntable drive	chain drive, worm gear		
Motor	electronic EC motor 300 W		
Drive unit	shielded and radio interference suppressed 20 dB under Class B		
Operating voltage	230 V 50 / 60 Hz (optional 110 V)		
Current consumption	max. 3.2 A		
Temperature range	+8 °C...+40 °C		

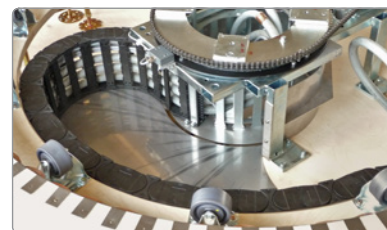



## | 4.8 | HIGH LOAD – STAINLESS STEEL COVER (DT) – PART 1

The DT turntables are specifically designed for installation either at intermediate levels in electromagnetic absorption chambers or in open areas. The base plate is available in stainless steel. If a ground plane exists, and the carrying plate is made of steel, then the adapter contact ring with a quadratic rim can be supplied.

The GPIB (IEEE 488) & LAN (TCP/IP) interface, when operated with the CO 3000 Controller, provides an additional control option for all functions.

### HIGH LOAD TURNTABLES – STAINLESS STEEL COVER (DT)

Type	Description	Article No.
DT 2000-2t	Ø 2000 mm, height 300 mm, load 2000 kg	80000047
DT 3000-3t	Ø 3000 mm, height 400 mm, load 3000 kg	80000052
DT 4000-4t	Ø 4000 mm, height 500 mm, load 4000 kg	80000058

### ACCESSORIES

Type	Description	Article No.
-HP	High precision positioning (0.1 angular degree)	80004886
-O	OATS kit for DTXX00 series	80004887
-ER	Endless turning (permanent positioning)	80004888
-EC	Energy chain (no cable installation)	80004889
-SS	Limit switch system	80004890
-t	Higher capacity for turntable DT series	80004891
-CF	Cooling fan for airstream	80004892
-3rpm	Maximal speed up to 3rpm	80004877
-IT-XX00	Integrated turntable (diameter)	80004894
-RPS	Preparation for RPS	80004895
-EG	Exhaust gas system with 1 connector on the turntable	80004896

### SCOPE OF DELIVERY

Type	Quantity
Interface to CO 3000	1 x
Power supply cable	1 x 3 m
Fiber optic cable	1 x 5 m, 1 x 10 m
FSMA	2 x
Standard CP	1 x
Operating manual	1 x



TECHNICAL DATA			
TYPE	DT2000-2T	DT3000-3T	DT4000-4T
Diameter	2000 mm	3000 mm	4000 mm
Permissible load	2000 kg	3000 kg	4000 kg
Height	min. 300 mm	min. 400 mm	min. 500 mm
Material of carrier plate	stainless steel 5 mm		
Rotating speed	2.4...12.2 °/s	2.4...12.2 °/s	2.4...9 °/s
(without acceleration ramp)	0.4 rpm...2.0 rpm	0.4 rpm...2.0 rpm	0.4 rpm...1.5 rpm
Positioning accuracy	±0.3 °		
Rotating angle	-200...+400 °		
Squarish environment	2400 x 2400 mm	3400 x 3400 mm	4500 x 4500 mm
Ground plane connecting every	50 mm		
Control cable	fiber optic (polymer type)		
Turntable drive	gear motor		
Motor	asynchron motor, frequency inverted		
Control cabinet for drive	shielded and radio interference suppressed under EN 55022 class B		
Drive motor	0.37 kW	0.55 kW	1.1 kW
Connector panel	fixed in the centre		
Operating voltage	230 V 50 / 60 Hz (optional 400 V)		
Current consumption	16 A		
Temperature range	+8 °C...+40 °C		

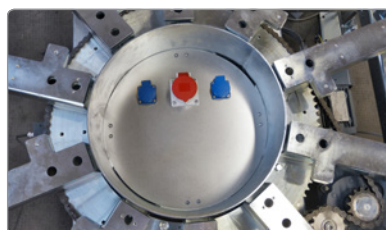
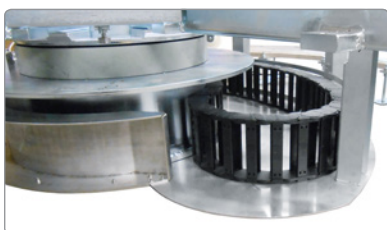
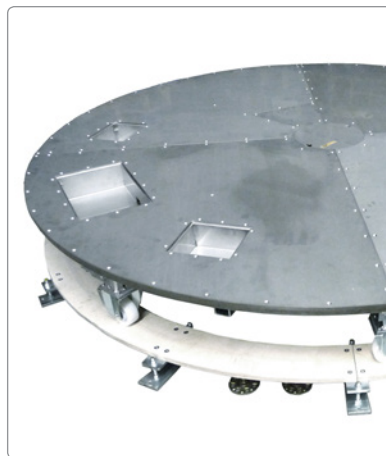
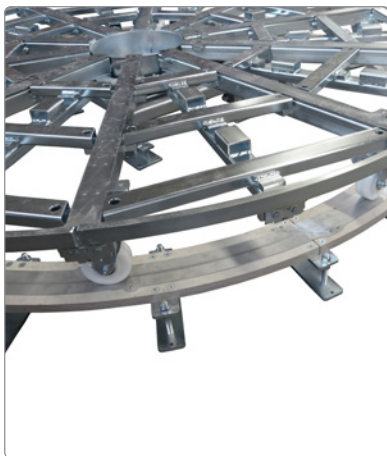



## | 4.8 | HIGH LOAD – STAINLESS STEEL COVER (DT) – PART 2

The DT turntables are specifically designed for installation either at intermediate levels in electromagnetic absorption chambers or in open areas. The base plate is available in stainless steel. If a ground plane exists, and the carrying plate is made of steel, then the adapter contact ring with a quadratic rim can be supplied.

The GPIB (IEEE 488) & LAN (TCP/IP) interface, when operated with the CO 3000 Controller, provides an additional control option for all functions.

### HIGH LOAD TURNTABLES – STAINLESS STEEL COVER (DT)

Type	Description	Article No.
DT 5000-5t	Ø 5000 mm, height 600 mm, load 5000 kg	80005627
DT 8000-15t	Ø 8000 mm, height 1000 mm, load 15 000 kg	80007127

### ACCESSORIES

Type	Description	Article No.
-HP	High precision positioning (0.1 angular degree)	80004886
-O	OATS kit for DTXX00 series	80004887
-ER	Endless turning (permanent positioning)	80004888
-EC	Energy chain (no cable installation)	80004889
-SS	Limit switch system	80004890
-t	Higher capacity for turntable DT series	80004891
-CF	Cooling fan for airstream	80004892
-3rpm	Maximal speed up to 3rpm	80004877
-IT-XX00	Integrated turntable (diameter)	80004894
-RPS	Preparation for RPS	80004895
-EG	Exhaust gas system with 1 connector on the turntable	80004896

### SCOPE OF DELIVERY

Type	Quantity
Interface to CO 3000	1 x
Power supply cable	1 x 3 m
Fiber optic cable	1 x 5 m, 1 x 10 m
FSMA	2 x
Standard CP	1 x
Operating manual	1 x

TECHNICAL DATA		
TYPE	DT5000-5T	DT8000-15T
Diameter	5000 mm	8000 mm
Permissible load	5000 kg	15000 kg
Height	min. 600 mm	min. 1000 mm
Material of carrier plate	stainless steel 5 mm	
Rotating speed	1.8...7.6 °/s	1.2...6.0 °/s
(without acceleration ramp)	0.3 rpm...1.3 rpm	0.2 rpm...1.0 rpm
Positioning accuracy	±0.2 °	±0.3 °
Rotating angle	-200...+400 °	
Squarish environment	5500 x 5500 mm	8500 x 8500 mm
Ground plane connecting every	50 mm	
Control cable	fiber optic (polymer type)	
Turntable drive	gear motor	
Motor	asynchron motor, frequency inverted	
Control cabinet for drive	shielded and radio interference suppressed under EN 55022 class B	
Drive motor	2.2 kW	2 x 4.0 kW (approx.)
Connector panel	fixed in the centre	
Operating voltage	230 V 50 / 60 Hz (optional 400 V)	
Current consumption	16 A	32 A
Temperature range	+8 °C...+40 °C	

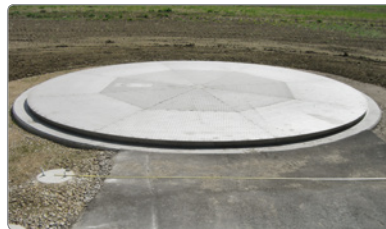



## | 4.9 | HIGH LOAD DUAL – STAINLESS STEEL COVER (DDT) – PART 1

The DDT turntables are specifically designed for installation either at intermediate levels in electromagnetic absorption chambers or in open areas. The base plate is available in stainless steel. If a ground plane exists, and the carrying plate is made of steel, then the adapter contact ring with a quadratic rim can be supplied.

The GPIB (IEEE 488) & LAN (TCP/IP) interface, when operated with the CO 3000 Controller, provides an additional control option for all functions.

### HIGH LOAD DUAL TURNTABLES WITH STAINLESS STEEL COVER (DDT)

Type	Description	Article No.
DDT 3000/1500-3t	Ø 3000 / 1500 mm, height 600 mm, load 3000 kg	80005075
DDT 4000/2000-3t	Ø 4000 / 2000 mm, height 750 mm, load 3000 kg	80006677

### ACCESSORIES

Type	Description	Article No.
-HP	High precision positioning (0.1 angular degree)	80004886
-O	OATS kit for DDTXX00 series	80004887
-ER	Endless turning (permanent positioning)	80004888
-EC	Energy chain (no cable installation)	80004889
-SS	Limit switch system	80004890
-t	Higher capacity for turntable DDT series	80004891
-CF	Cooling fan for airstream	80004892
-3rpm	Maximal speed up to 3rpm	80004877
-EG	Exhaust gas system with 1 connector on the turntable	80004896

### SCOPE OF DELIVERY

Type	Quantity
Interface to CO 3000	2 x
Power supply cable	2 x 3 m
Fiber optic cable	2 x 5 m, 2 x 20 m
FSMA	4 x
Operating manual	1 x

TECHNICAL DATA

TYPE	DDT3000/1500-3T	DDT4000/2000-3T
Diameter (main / inner turntable)	3000 mm / 1500 mm	4000 mm / 2000 mm
Permissible load (main / inner turntable)	3000 kg / 3000 kg	
Rotating speed (main / inner turntable) (without acceleration ramp)	3...12 / 3...12 °/s 0.5...2.0 / 0.5...2.0 rpm	
Positioning accuracy (main / inner turntable)	better ±0.3 ° / better ±0.3 °	
Rotating angle (main / inner turntable)	-20...+380 ° / -20...+380 °	-200...+400 ° / -200...+400 °
Height (entire)	min. 600 mm	min. 750 mm
Material of carrier plate	stainless steel ~ 5 mm	
Squarish environment	3400 x 3400 mm	4500 x 4500 mm
Ground plane connecting every	50 mm	
Control cable	fiber optic (polymer type)	
Turntable drive	gear motor	
Motor	asynchron motor, frequency inverted	
Control cabinet for drive	shielded and radio interference suppressed under EN 55022 class B	
Drive motor (main / inner turntable)	~ 0.75 kW / 0.25 kW	~ 1.5 kW / 0.75 kW
Connector panel	fixed in the centre	
Operating voltage	230 V 50 / 60 Hz (optional 400 V)	
Current consumption	16 A	32 A
Temperature range	+8 °C...+40 °C	

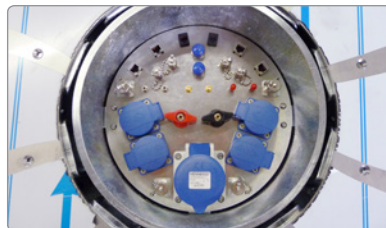
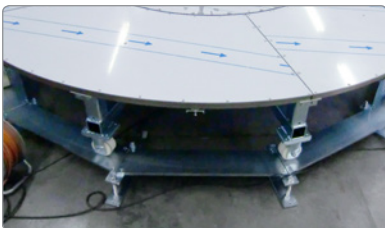
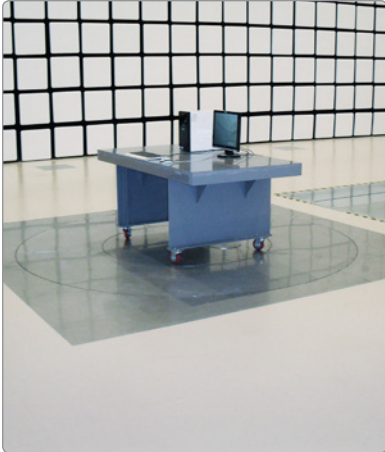



## | 4.9 | HIGH LOAD DUAL – STAINLESS STEEL COVER (DDT) – PART 2

The DDT turntables are specifically designed for installation either at intermediate levels in electromagnetic absorption chambers or in open areas. The base plate is available in stainless steel. If a ground plane exists, and the carrying plate is made of steel, then the adapter contact ring with a quadratic rim can be supplied.

The GPIB (IEEE 488) & LAN (TCP/IP) interface, when operated with the CO 3000 Controller, provides an additional control option for all functions.

### HIGH LOAD DUAL TURNTABLES WITH STAINLESS STEEL COVER (DDT)

Type	Description	Article No.
DDT 5000/3000-5t	Ø 5000 / 3000 mm, height 700 mm, load 5000 kg	80007062
DDT 6000/3000-5t	Ø 6000 / 3000 mm, height 500 mm, load 5000 kg	80007061

### ACCESSORIES

Type	Description	Article No.
-HP	High precision positioning (0.1 angular degree)	80004886
-O	OATS kit for DDTXX00 series	80004887
-ER	Endless turning (permanent positioning)	80004888
-EC	Energy chain (no cable installation)	80004889
-SS	Limit switch system	80004890
-t	Higher capacity for turntable DDT series	80004891
-CF	Cooling fan for airstream	80004892
-3rpm	Maximal speed up to 3rpm	80004877
-EG	Exhaust gas system with 1 connector on the turntable	80004896

### SCOPE OF DELIVERY

Type	Quantity
Interface to CO 3000	2 x
Power supply cable	2 x 3 m
Fiber optic cable	2 x 5 m, 2 x 20 m
FSMA	4 x
Operating manual	1 x



TECHNICAL DATA

TYPE	DDT5000/3000-5T	DDT6000/3000-5T
Diameter (main / inner turntable)	5000 mm / 3000 mm	6000 mm / 3000 mm
Permissible load (main / inner turntable)	5000 kg / 5000 kg	
Rotating speed (main / inner turntable)	1.8...6 / 3...12 °/s	
(without acceleration ramp)	0.3...1.0 / 0.5...2.0 rpm	
Positioning accuracy (main / inner turntable)	better ±0.3 ° / better ±0.3 °	
Rotating angle (main / inner turntable)	-20...+380 ° / -20...+380 °	
Height (entire)	min. 700 mm	min. 500 mm
Material of carrier plate	stainless steel ~ 5 mm	
Squarish environment	5500 x 5500 mm	6500 x 6500 mm
Ground plane connecting every	50 mm	
Control cable	fiber optic (polymer type)	
Turntable drive	gear motor	
Motor	asynchron motor, frequency inverted	
Control cabinet for drive	shielded and radio interference suppressed under EN 55022 class B	
Drive motor (main / inner turntable)	~ 2 x 0.75 kW / 2 x 0.55 kW	~ 2.2 kW / 1.5 kW
Connector panel	fixed in the centre	
Operating voltage	230 V 50 / 60 Hz (optional 400 V)	
Current consumption	32 A	
Temperature range	+8 °C...+40 °C	

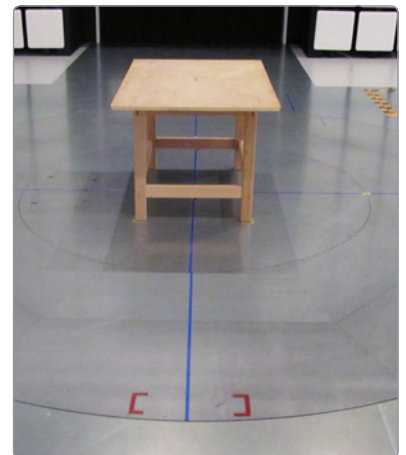
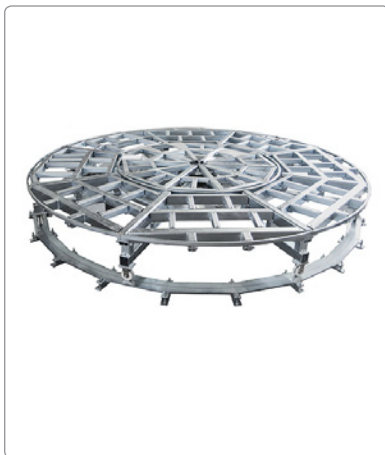









## | 5 | DYNAMOMETERS

innco systems EMC Chassis dynamometer Systems (sometimes referred to as a “rolling road”), used in the development and homologation for automotive industry, are specifically designed to be used in electromagnetic absorption chambers.

EMC measurements are the main aspect of the design and control systems. We have developed over several years unique designs including a “Zero Emissions” system.

We have two main systems, for integration into a turntable or as “Free Standing” design which can be transported into and out of the EMC facility. The systems can be designed for front wheel drive, rear wheel drive, four wheel drive and free wheel drive types. The newly developed DynamPro 4.0 software provides accurate and simple operations for all system functions.

## | 5.1 | PRODUCT OVERVIEW

### COUPLED FREE ROLLER (FRC)

- Easy to setup in the chamber
- Mechanically coupled rollers
- Up to 2 ton vehicle weight



### FREE STANDING (RPS-F)

- Easy to setup in the chamber
- Electrically coupled rollers (active driven)
- Full functionality as integrated dyno



### INTEGRATED FOR TURNTABLES (RPS-DT)

- EMC design
- Zero emission execution
- Integrated maintenance area
- Full functionality for all EMC test requirements



### EMBEDDED FOR CHAMBER FLOOR (RPS-E)

- Integrated in chamber floor
- Low height needed
- Zero emission execution
- Full functionality for all EMC test requirements



### CONTROL SOFTWARE (DYNAM-PRO)

- Installed on standard PC
- Adaptable to customer needs
- Full functionality for all EMC test requirements



### DRIVING ROBOTS

- Pneumatic or electric driven
- Controllable by Dynam software
- High resolution
- Fixing adapters for all vehicle brands





## | 5.2 | COUPLED FREE ROLLER (FRC)

The coupled free roller FRC 500-1730-F is a free standing testbench as free roller with coupled rollers. The FRC 500-1730-F synchronizes the wheels of the vehicle what is necessary for monitored tires (if ABS or ESP existing).

The FRC 500-1730-F is specially designed to be used in EMC chambers. The low height and the large area grounding minimises the influence on the test to perform. The two modules for the left / right tires were installed separately before they are coupled by an axle to eliminate also eventual speed drop by the vehicle.

Without coupling axle one single module of the FRC 500-1730-F can be used also as basis for testings of motorcycles.

Optionally a speed sensor can be installed for the monitoring of the vehicle or for the connection to a robot system.

### COUPLED FREE ROLLER (FRC)

Type	Description	Article No.
FRC 500-1730-F	Axle distance up to 3 m, vehicle weight up to 1.8 ton	80001277

### ACCESSORIES

Description	Article No.
Increased payload	On request
Speed sensor (for robot control)	On request
Shorter distance (e.g. for motorcycles)	On request
Calvanised cover plates (instead of GRP) for the space between the roller pairs	On request
Support profiles made of GRP	On request
Support profile rollers for installations on turntables smaller $\varnothing$ 3.8 m	On request

### SCOPE OF DELIVERY

Type	Quantity
Ramps for loading/unloading	1 set
Rollers for easy movement	1 set
Fixing belts	4 x
Scale for adjusted distance	1 x
GRP inlays for the constant spaces	3 pairs
Galvanised steel inlays for the adjustable space	1 set
Fixing bolts for support frame	8 x



TECHNICAL DATA

TYPE	FRC 500-1730-F
Axle distance	1750 ... 3000 mm
Vehicle weight / axle load	max. 1800 kg / 900 kg
Total length	up to 3300 mm
Total height	approx. 120 mm
Roller diameter	100 mm
Roller length	500 mm
Inner / outer roller edges	1000 / 2000 mm
Width of supporting profile frame	approx. 2450 mm
Length / circumference of supporting profiles	3030 mm / Ø 3810 mm
Max. speed	above 50 km/h
Motor	-
Total weight / handling weight	approx. 450 kg / 200 kg
Operating voltage	230 V 50 / 60 Hz (optional 400 V)
Temperature range	+8 °C...+40 °C

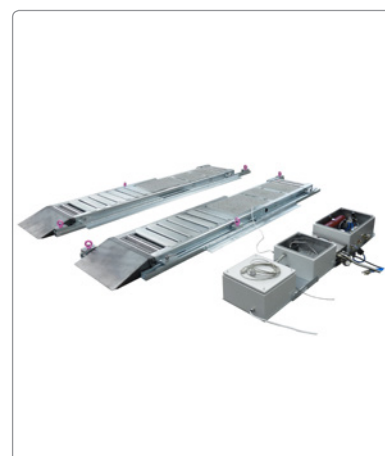



### | 5.3 | FREE STANDING (RPS-F)

The free standing dynamometer RPS-F is designed to be used in an electromagnetic absorption chamber for EMI, EMC & EMS measurements. The free-standing design allows a quick setup and storage either on top of a turntable or on chamber floor. In the execution with two active axles, the dynamometer can be used for cars with front / rear wheel drive as well as 4WD. Each car wheel is driven by a separate motor / generator.

All electronic components are located inside the modules in a shielded and radio interference suppressed cabinet. The typical emission level is below the CISPR 22 class B regulation. The immunity against field strength up to 200 V/m is guaranteed. A noise-free (zero emission) execution is optionally available.

FREE STANDING DYNAMOMETER (RPS-F)		
Type	Description	Article No.
RPS04-100-F	Axle load: 1800 kg, max. speed 100 km/h Passive type: no motors	80005115
RPS40-55/100-7-F	Axle load: 1800 kg, max. speed 100 km/h Active type: max. acceleration / deceleration 0.7 g	80007078

ACCESSORIES	
Description	Article No.
Different axle load	On request
Different motor power	On request
Different max. speed	On request

SCOPE OF DELIVERY	
Type	Quantity
Access ramp	1 set
Dyno module connection bridge	1 set
Hydraulic lifting system	1 x
Metal free exhaust tube with stand	1 set
Vehicle fixing elements	1set
Roller protection cover	4 x
Power feedback unit for less heat-load	1set

TECHNICAL DATA		
TYPE	RPS04-100-F	RPS40-55/100-7-F
Permissible axle load	max. 1800 kg	1800 kg
Diameter car wheels	min. 400 mm	
Distance between roller edges	in 900 mm	in 900 mm
	out 2400 mm	out 2100 mm
Distance between the axles typical	1200...3200 mm	
Height of roller stand	approx. 325 mm	
Diameter rollers (roller pairs)	240 mm	
Complete weight	approx. 2500 kg	approx. 3000 kg
Operating voltage	400 V 50 / 60 Hz (3phase +PE)	
Temperature range	+8 °C...+40 °C	
<b>Specifications: passive axles</b>		
Max. speed	100 km/h	–
<b>Specifications: active axles</b>		
Max. speed	–	100 km/h
2 drive / brake AC motor/generator	–	each 12 kW
2 frequency inverter	–	each 12 kW
1 regenerating unit needed power supply <sup>1</sup>	–	400 V / 125 A
Wiring	–	3 phase + PE
Acceleration	–	max. 7 m/s <sup>2</sup>
Deceleration	–	max. 7 m/s <sup>2</sup>
Up to a speed of	–	55 km/h
Speed measurement and control accuracy	–	better ± 0.2 km/h
Emission	–	-15 dB less than the limits of CISPR 22
Frequency range	–	150 kHz...1 GHz
Measuring point	– above the floor level	1 m
	– distance to the system centre	5 m
Immunity / field strength	–	200 V/m
Frequency range	–	10 kHz...18 GHz

<sup>1</sup> Filter requirement





## | 5.4 | INTEGRATED FOR TURNTABLES (RPS-DT)

The integrated dynamometer RPS-DT are designed to be used in an electromagnetic absorption chamber for EMI, EMC & EMS measurements. The integrated design into a turntable allows easy handling for daily usage. Two active axles are used for cars with front / rear wheel drive as well as 4WD. Each car wheel is driven by a separate motor / generator.

All electronic components are located below the groundplane in shielded and radio interference suppressed cabinets at the maintenance area of the turntable. The typical emission level is below the CISPR 22 class B regulation. The immunity against field strength up to 200 V/m is guaranteed. The noise-free (zero emission) execution is as standard included.

### INTEGRATED DYNAMOMETER FOR TURNTABLES (RPS-DT)

Type	Description	Article No.
RPS40-60/120-5-DT	Axle load: 2500 kg, max. speed: 120 km/h, max. acceleration / deceleration: 0.5 g	80005276
RSP40-90/150-10-DT	Axle load: 2500 kg, max. speed: 150 km/h, max. acceleration / deceleration: 1.0 g	80006674
RPS40-90/200-12-DT	Axle load: 2500 kg, max. speed: 200 km/h, max. acceleration / deceleration: 1.2 g	80005776

### ACCESSORIES

Description	Article No.
Different axle load	On request
Different axle distances	On request
Different motor power	On request
Different max. speed	On request

### SCOPE OF DELIVERY

Type	Quantity
Stainless steel cover plate	1 set
Shutter system for module shifting	1 set
Vehicle cooling fan	1 x
Non-conductive air cowling	1 x
Metal free exhaust tube with stand	2 sets
Vehicle fixing elements with storage boxes	1 set
Roller protection cover	4 x
NSA cover	1 set
Dyno chamber control panel	1 x
Power feedback unit for less heat-load	1 set

TECHNICAL DATA

TYPE	RPS40-60/120-5-DT	RSP40-90/150-10-DT	RPS40-90/200-12-DT	
Max. permissible load per axle	2500 kg			
Diameter car wheels	min 400 mm			
Distance between...	inner roller edges	1000 mm	700 mm	1000 mm
	outer roller edges	2100 mm	2300 mm	2100 mm
Length of roller	550 mm	800 mm	550 mm	
Roller pairs	4 pcs			
Diameter of roller	240 mm			
4drive / brake AC motor / generator				
with each nominal power per tire	12 kW	44 kW	44 kW	
Temperature range	+8 °C...+40 °C			
<b>To perform:</b>				
Acceleration / deceleration	5 m/s <sup>2</sup>	10 m/s <sup>2</sup>	12 m/s <sup>2</sup> (in overload mode)	
Up to	60 km/h	90 km/h	90 km/h	
Max. speed	120 km/h	150 km/h	200 km/h	
Speed measurement and control accuracy	better ± 0.2 km/h			
Operating voltage	400 V 50 / 60 Hz (3phase +PE)			
Wiring	3 phase + PEN			

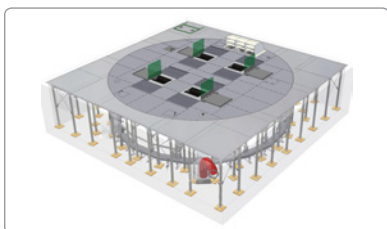





## | 5.5 | EMBEDDED FOR CHAMBER FLOOR (RPS-E)

The embedded dynamometer RPS-E are designed to be used in an electromagnetic absorption chamber for EMI, EMC & EMS measurements. The integrated design into the chamber floor allows easy handling for daily usage. Two active axles are used for cars with front / rear wheel drive as well as 4WD. Each car wheel is driven by a separate motor / generator.

All electronic components are located below the groundplane in shielded and radio interference suppressed cabinets. The typical emission level is below the CISPR 22 class B regulation. The immunity against field strength up to 200 V/m is guaranteed. The noise-free (zero emission) execution is as standard included.

### EMBEDDED DYNAMOMETER FOR CHAMBER FLOOR (RPS-E)

Type	Description	Article No.
RPS40-55/100-6-E	Axle load: 1250 kg, max. speed: 100 km/h, max. acceleration / deceleration: 0.5 g	80006840
RPS40-55/100-10-E	Axle load: 1500 kg, max. speed: 100 km/h max. acceleration / deceleration: 1.0 g	80006783

### ACCESSORIES

Description	Article No.
Different axle load	On request
Different axle distances	On request
Different motor power	On request
Different max. speed	On request

### SCOPE OF DELIVERY

Type	Quantity
Stainless steel cover plate	1 set
Shutter system for module shifting	1 set
Vehicle cooling fan	1 x
Non-conductive air cowling	1 x
Metal free exhaust tube with stand	1 set
Vehicle fixing elements with storage boxes	1 set
Roller protection cover	4 x
NSA cover	1 set
Dyno chamber control panel	1 x
Power feedback unit for less heat-load	1 set



TECHNICAL DATA

TYPE	RPS40-55/100-6-E	RPS40-55/100-10-E
Max. permissible load per axle	1250 kg	1500 kg
Diameter car wheels	min 400 mm	
Distance between...	inner roller edges	900 mm
	outer roller edges	2100 mm
Length of roller	600 mm	
Diameter of roller	240 mm	
Distance between the axles	2400...3800 mm	1800...3200 mm
Height roller stand	approx. 320 mm	
4drive / brake AC motor / generator with each nominal power per tire	12 kW	22 kW
Temperature range	+8 °C...+40 °C	
<b>To perform:</b>		
Acceleration / deceleration	6 m/s <sup>2</sup>	10 m/s <sup>2</sup>
Up to	55 km/h	
Max. speed	100 km/h	
Speed measurement and control accuracy	better ± 0.2 km/h	
Operating voltage	400 V 50 / 60 Hz (3phase +PE)	
Wiring	3 phase + PEN	



## | 5.6 | FEATURES FOR RPS

innco systems dynamometers provide a big number of features in standard delivery scope.

Additionally available are features, which were developed together with our customers to realize their needs and make their everyday work more safe and efficient.

The pictures below show a small overview of the included and additionally available equipment for the dynamometer test system.



- 1 Optional tire cooling fan outlet integrated in the roller protection cover
- 2 Optional manual throttle jig with clamp unit for steering wheel
- 3 Roller protection cover (metal free)
- 4 Hand Control Unit on tablet PC for full dyno functionality

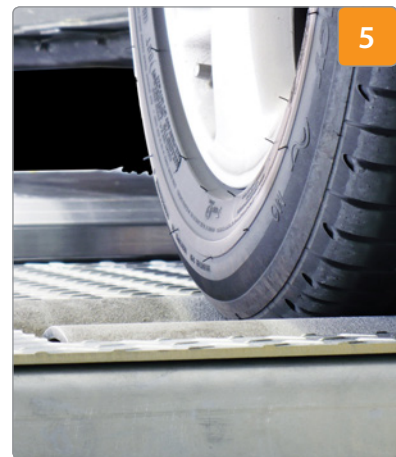
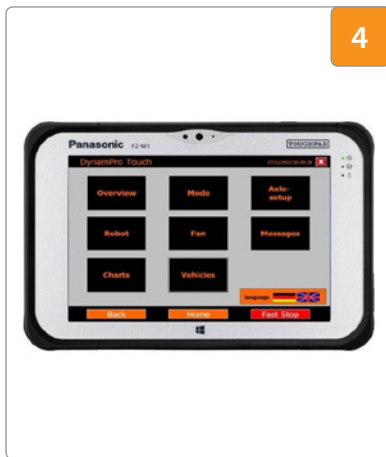

- 5 Twin roller design
- 6 Metal free exhaust tube with metal free tube-stand



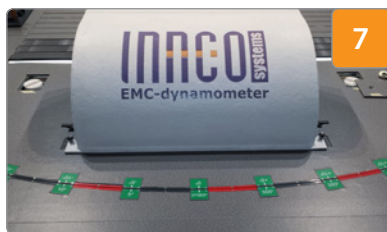

- 7 Air cowling (metal free) with integrated lowable rollers for easy movement & setup
- 8 Fixing belts with integrated storage boxes
- 9 Fixed vehicle on dynamometer with exhaust tube and roller protection cover
- 10 Optional integrated connector panels
- 11 Roller protection cover (metal free)
- 12 Metal free exhaust tube up to 200 °C with metal tube-stand
- 13 Horizontal fixing pillar (metal free) storage below turntable surface





## | 5.7 | CONTROL SOFTWARE (DYNAM-PRO)



The expandable dynamometer control software Dynam-Pro was developed by SIEMENS & innco systems, based on long experience with dynamometer control and in direct contact with several customers.

The design was focused to enable an intuitive operation of the needed functionality for EMC test requirements .

The SIEMENS engineers take an additional focus on the performance between the used hardware components and software interface.

In combination with the used high speed PLC, quickest control functionality is possible to handle each test requirement, also for future upgrades.

Installed on a Windows PC as human interface, the dynamometer can be connected to the company network structure for storing log files or remote control of the dyno system.

The installed remote maintenance software guarantees a quick check of the system status and allows system modifications, if required.

### CONTROL SOFTWARE (DYNAM-PRO)

Type	Description	Article No.
DYNAM-PRO	Installed on PC with 24" monitor and Profinet-Fiber optic interface to dynamometer	80006783

### SCOPE OF DELIVERY

Type	Quantity
PC with installed Dynam-Pro software	1 x
24" monitor, mouse & keyboard	1 x
Dynamometer interface controller	1 x
Emergency stop for control room	1 x

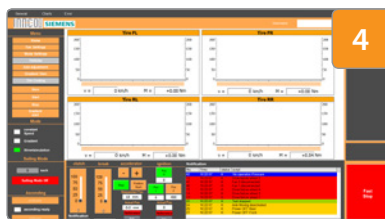

- 1 Dynam-Pro home screen
- 2 Dynam-Pro cooling fan settings
- 3 Dynam-Pro auto axle-adjustment settings
- 4 Dynam-Pro gradient overview screen

- 5 Drive in/out brake activation window. The brake can be activated either by software or by chamber control panel.
- 6 Constant speed settings screen. The speed can be edited at running test.
- 7 Gradient mode settings screen. Created gradients can be stored / loaded with and without base-speed.
- 8 Axle adjustment screen. The axle setup can be done by software or by optionally switches on chamber control panel.
- 9 Notification window provides information about system errors and chosen settings.

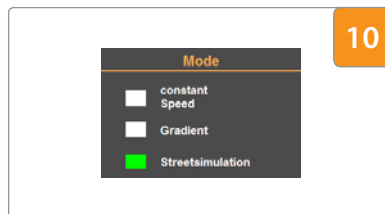
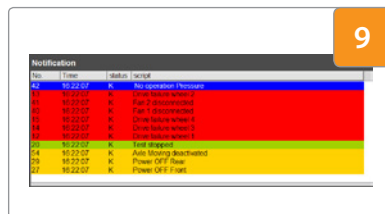
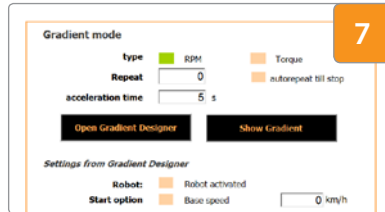
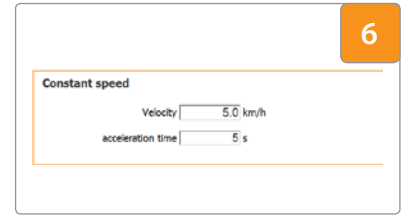

- 10 Operation mode window. Dynam Pro Software provides three main operation modes:
  - Constant speed
  - Gradient profile
  - Street simulation

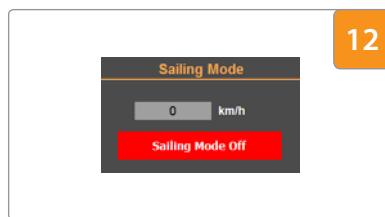
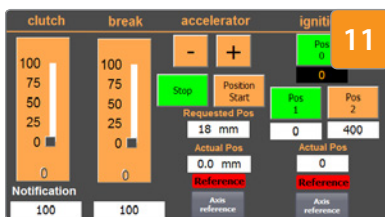

- 11 Robot control window with teach-in function for ignition key / pushbutton actuator
- 12 New feature for HV and EV: coast down or sailing mode
- 13 Status window provides information about actual test mode and operation status.

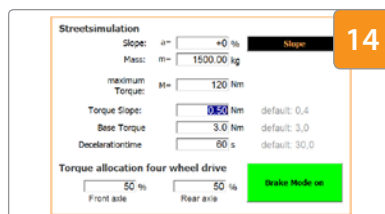

- 14 Adjustment screen for street simulation mode



## | 5.8 | DRIVING ROBOT

The dynamometer driving robots enable the automated/remote pedal operation of the vehicles under test. The device is built of two handy main units: the compact actuator unit and the control unit. The actuator units could be made optionally metal free, if required for using inside of EMC chambers. The control unit is usually located below the groundplane / carrier plate of the turntable.

The driving robot can be easily connected to the DynamPro-PLC as used in innco systems dynamometer. In this case the operation is embedded in DynamPro software.

The universal analog interface (optional) with 0...10 V input allows further the operation by third party control systems.

DRIVING ROBOT		
Type	Description	Article No.
PB08-W	Electric driven pedal actuator, 75 mm moving range, 100 N	80007166
GBK081520-WDD	Robot system with electric driven throttle actuator and pneumatic driven brake & clutch actuator	80005740

ACCESSORIES	
Description	Article No.
Additional brake actuator (PB08-W)	On request
Additional clutch actuator (PB08-W)	On request
Footwell placement (instead of seat placement) (GBK081520-WDD)	On request
Cabinet unit for installation on turntable / groundplane (GBK081520-WDD)	On request
Combined unit (GBK081520-WDD)	On request
CCTV camera mount (GBK081520-WDD)	On request
DynamLight-PC for stand-alone setup (GBK081520-WDD)	On request
Ignition key actuator (both)	On request
Different pedal range(s) (both)	On request
Different pedal force(s) (both)	On request

SCOPE OF DELIVERY	
Type	Quantity
Optical link module as interface to PLC and DynamPro-PC (PB08-W)	1 x
Connector panel (PB08-W)	1 x
Steering wheel fixture (GBK081520-WDD)	1 x
Fixing elements for vehicle seat rail	1set



TECHNICAL DATA		
TYPE	PB08-W	GBK081520-WDD
Actuator unit	for throttle	for throttle + brake + clutch
Throttle actuator: moving range / force	75 mm / 100 N	80 mm / 100 N
Brake actuator: moving range / force / acc.	–	150 mm / 150 N / n.s.
Clutch actuator: moving range / force / acc.	–	200 mm / 200 N / n.s.
Resolution of throttle movement	± 0.15 mm	
Material of actuator unit	mainly aluminium	throttle mainly aluminium brake and clutch 100 % plastics (metal free)
Cabinet unit with pneumatic control	shielded and radio interference sup- pressed for placement in the footwell	shielded and radio interference sup- pressed for installation beneath the groundplane
Length of connection line	standard:	
actuator unit <> control unit	1 m	–
control unit <> connector panel	3 m	–
lines to control panel	5 m	–
cabinet <> actuator	–	5 m
Pneumatic requirement	min. 6 bar	
Operating voltage	24 V DC (optional 230 V AC)	
interface to parent system		
in case of innco dynamometer	bus	
in case of universal input	0...10 V analog	0...10 V analog (each pedal)
in case of basic stand-alone	FO switches for CR to increase / decrease speed	–
Handling weight / total weight	approx. 7 kg / 15 kg	approx. 15 kg / 50 kg
Temperature range	+8 °C...+40 °C	

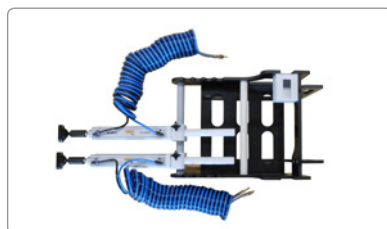
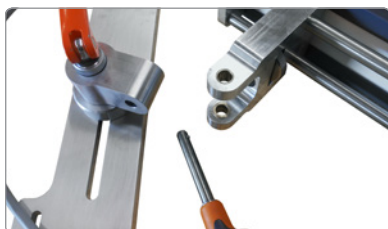
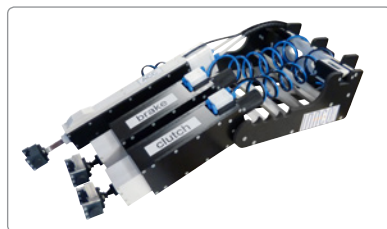







## | 6 | CONTROLLERS AND HAND CONTROL UNITS

The introduction of our new CO 3000 controller combines more than 20 years of experience, with research and development, taking into consideration feedback from existing and potential customers. The intuitive design provides a 7" TFT display, allowing easy and precise operation in manual, semi-automatic and remote control mode.

The controller supports Innco and innco systems positioning devices, which are controlled via fiber optic cables. The GPIB (IEEE) and LAN (TCP/IP) ports add additional control methods and for future upgrades.

innco systems also offers a Hand Control Unit (HCU) for use with up to 3 devices. The connection of the HCU can be by either fiber optic or wire cable.



## | 6.1 | PRODUCT OVERVIEW

### CONTROLLERS (CO)

- Control up to one, four or eight devices
- Fiber optic cable connection
- GPIB & TCP/IP for remote control
- Drive support by all measurement software providers



### HAND CONTROL UNIT (HCU)

- Control up to three devices
- Fiber optic cable connection
- EMC shielded for chamber usage
- Works with CO 2000 & CO 3000



### USB CONTROL (PC-USB)

- Control of one single device
- Fiber optic cable connection
- Incl. dll file for VB or C++
- Incl. demo program
- No external power supply needed



### GPIB INTERFACE BOX

- Control of one polarisation axis
- Fiber optic cable connection
- GPIB for remote control
- Electric switch for manual operation





## | 6.2 | CONTROLLERS (CO)

The digital Device-Controller CO 3000 can be used for the operation of antenna masts, turntables, slide bars and other positioning equipment of Innco and innco systems. This controller permits the operation in manual, semi-automatic and remote control mode (via IEEE 488 (GPIB) bus or TCP/IP (LAN) interface). The quick move buttons and programmable jog wheel enable an intuitive and quick operation in manual mode. The 7" display provides an brilliant overview of the actual position of each device.

### CONTROLLERS (CO)

Type	Description	Article No.
CO3000-1D	Controller for 1 single device, 4 independent device ports	80005753
CO3000-4p	Controller for up to 4 devices, 4 independent device ports	80005688
CO3000-8p	Controller for up to 8 devices, 8 independent device ports	80005689

### ACCESSORIES

Type	Description	Article No.
HCU Basic Port	Connect direct on the backside of CO 3000 by wire	80005053
HCU Direct Port	Connect direct on the backside of CO 3000 by fiber optic	80005618
Update 3000	Update Controller CO 3000-1D to CO 3000-4p (license key will be provided)	80000354

### SCOPE OF DELIVERY

Type	Quantity
Power supply cable	1 x 1.8 m
USB update cable	1 x 1 m
Device ports:	
CO3000-1D & CO3000-4p	4 x
CO3000-8p	8 x
GPIB interface	1 x
LAN interface	1 x
USB port (for update)	1 x
Operating manual	1 x



TECHNICAL DATA			
TYPE	CO3000-1D	CO3000-4P	CO3000-8P
Data interface	IEEE 488, LAN (optional RS 232)		
Device interface	4 Port CAN-Bus via fiber optic (polymer type) (up to 8 ports & glass cable type available)	4 Port CAN-Bus via fiber optic (polymer type) (up to 8 ports & glass cable type available)	8 Port CAN-Bus via fiber optic (polymer type) (glass cable type available)
Controllable devices	1 device (upgrade to 4 devices by licence key)	4 devices	8 devices
Transfer rate	500 kBit/s		
Display	7" TFT 840 x 400 pixel		
Operating voltage	110 / 230 V (50 / 60 Hz)		
Power	max. 20 W		
Fuse	T 1.25 A, 250 V		
Size	3HE 19" rack mount (448 x 135 x 250 mm)		
Weight	approx. 3 kg		
Temperature range	+8 °C...+40 °C		





### | 6.3 | HAND CONTROL UNIT (HCU)

The Hand Control Unit is designed for usage either inside chamber or even in control room. For inside chamber usage, the copper coating and auto-off function of the electronic guarantee no EMC interference during measurement. The fiber optic connection by POF or optionally GOF single phase cable, reduce the setup time.

The ergonomic designed foil-keypad guarantees a comfortable handling during operation. Three illuminated unit buttons show the actual device in remote operation.

The three status LEDs of the unit buttons are for indication of low battery voltage, if illuminated at the same time. In standard configuration are 3 AAA batteries used. An optional charger and accumulators are available on request.

HAND CONTROL UNIT (HCU)		
Type	Description	Article No.
HCU-LWL3	Connection by fiber optic cable, up to three devices	80006616

ACCESSORIES		
Type	Description	Article No.
HCU-LWL3-GOF	Connection for glass optical fiber	80005617
HCU basic Mast	Wire connection to CO 3000 for mast operation only	80005004
HCU basic Table	Wire connection to CO 3000 for table operation only	80005833
Charger for HCU	In combination with rechargeable batteries	On request

SCOPE OF DELIVERY	
Type	Quantity
Battery AAA (micro)	3 x
Fiber optic cable (simplex)	1 x 10 m
Operating manual	1 x

## TECHNICAL DATA

TYPE	HCU-LWL3
Size	115 x 65 x 26 mm (L x W x H)
Housing material	ABS, inside copper coated
Connection to controller	by fiber optic line POF or GOF
Operating voltage	3.2...4.5 V by 3 x 1.5 V AAA
Operating time by battery	approx. 30 h (while continues usage)
Auto-off	after 20 sec
Keypad	foil keypad
Temperature range	+8 °C...+40 °C





## | 6.4 | USB CONTROL (PC-USB)

Including

- Demo software in visual basic and C++ for the controlling of all functions of mast, turntable, antenna stands and turndevices
- Converter from USB to fiber optic
- dll-files and sourcecode for possibility of further processing of the software

### USB CONTROL (PC-USB)

Type	Description	Article No.
USB Control (PC-USB)	USB – fiber optic converter	80000230

### ACCESSORIES

Description	Article No.
5 m fiber optic cable for USB converter with FSMA/RP-02 connectors	21001268

### SCOPE OF DELIVERY

Type	Quantity
USB – fiber optic converter	1 x
Fiber optic cable	1 x 5 m
innco dll file	1 x
Demo software	1 x
Programming description	1 x



## | 6.5 | GPIB INTERFACE BOX



The GPIB Interface Box is designed for the simple operation of antenna stands or polarisation units. The installed switches enable the control in manual or remote control mode (via IEEE 488 / GPIB bus). The GPIB address can be modified by internal DIP-switches. The device works as listener only; optional available fiber optic switches can be installed on the device to indicate the actual-position.

### GPIB INTERFACE BOX

Type	Description	Article No.
GPIB Interface Box	Interface box for polarisation control by fiber optic cable	80600014

### ACCESSORIES

Type	Description	Article No.
-2 AS	GPIB interface for two antenna stands	On request
-3 AS	GPIB interface for three antenna stands	On request
-4 AS	GPIB interface for four antenna stands	On request

### SCOPE OF DELIVERY

Type	Quantity
Power supply cable	1 x 1.8 m
Device port	1 x
GPIB interface	1 x
Operating manual	1 x



TECHNICAL DATA	
TYPE	GPIB INTERFACE BOX
Data interface	IEEE 488 / GPIB (listener only) (primary and secondary address necessary)
Device interface	1 port via fiber optic (polymer type) (up to 4 ports available)
Transfer mode	Light signal
Switches for	Remote or manual operation H / V polarisation (in manual mode)
Operating voltage	110 / 230 V (50/60Hz)
Current consumption	approx. 20 W
Fuse	T 125 mA, 250 V
Size	181 x 300 x 68 mm (L x W x H)
Weight	approx. 2 kg
Temperature range	+8 °C...+40 °C



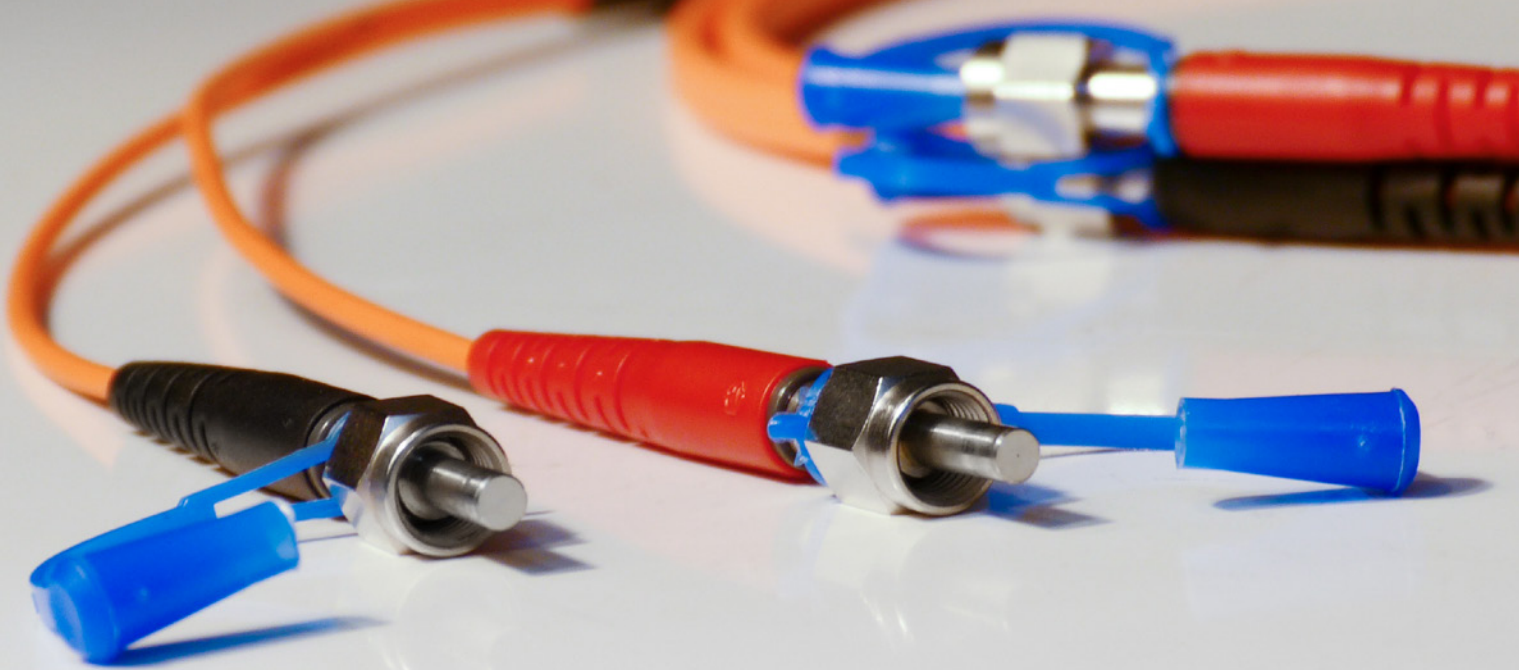
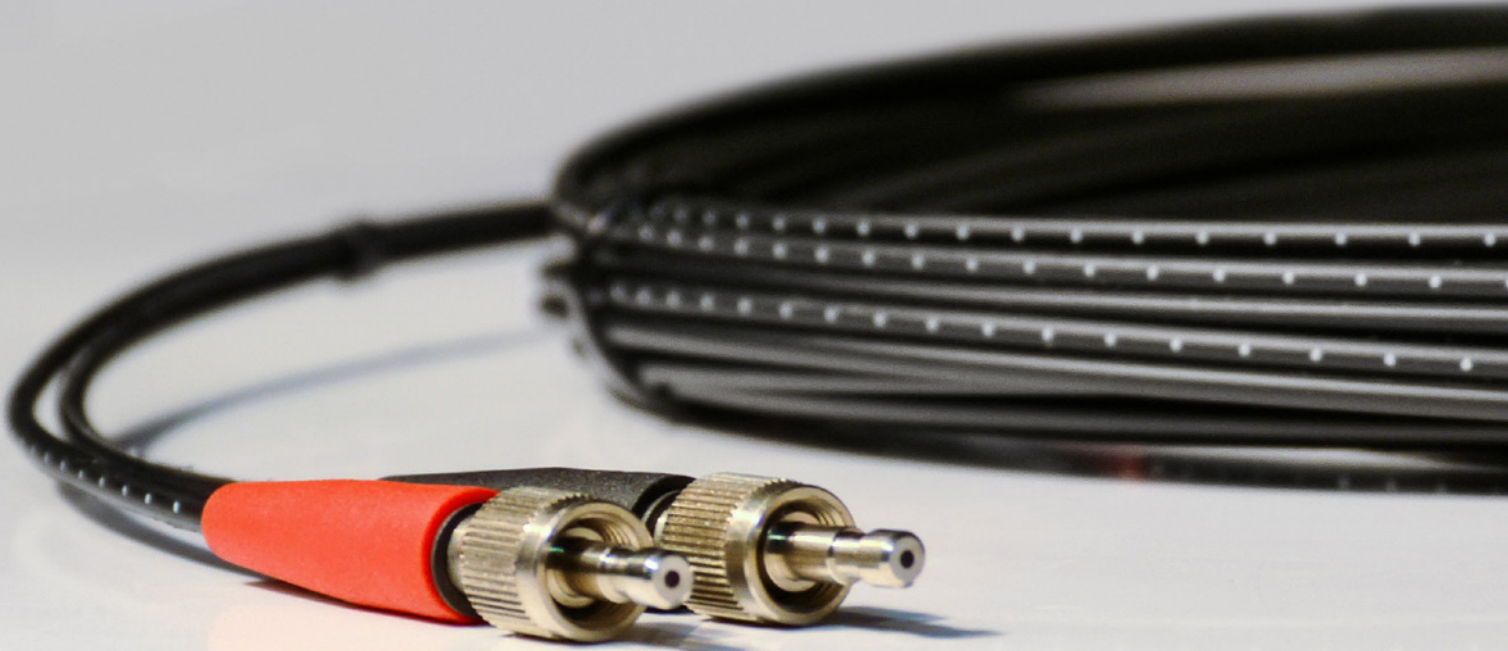



## | 7.1 | FIBER OPTIC CABLES

innco systems devices are usually controlled by fiber optic cables, to minimize electro-magnetic interference during the EMC test.

Typical are Polymer Optical Fibers (POF) with FSMA connectors used.

In case of long distances between controller and the device, Glass Optical Fibers (GOF) with FSMA connectors will be used. For projects in Open Area Test Sites, the cables will be equipped with an special mechanical protection cover.

Each innco systems device does include automatically fiber optic cables in the scope of delivery.

## | 7.2 | CABLE LENGTH

Up to 50 m: Polymer Optical Fibers (POF), black cable

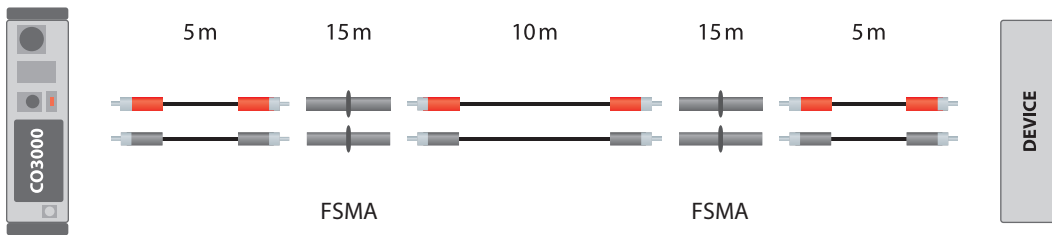

More than 50 m: Glass Optical Fibers (GOF) , orange cable

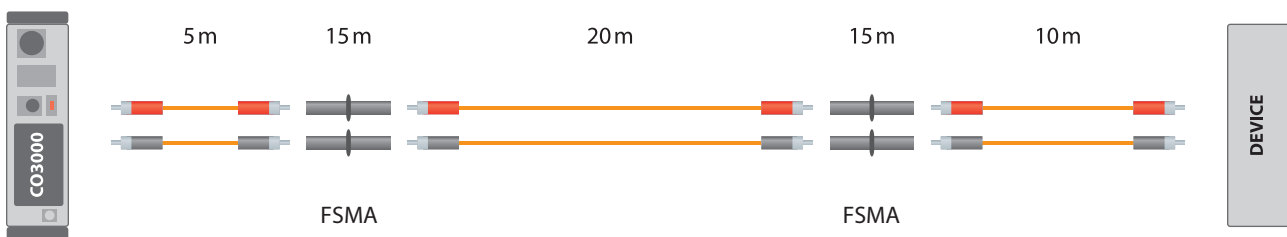

### | 7.3 | POF / GOF KNOWLEDGE



- POF**
- Polymer Optical Fiber
  - Black cable
  - Full intensity light

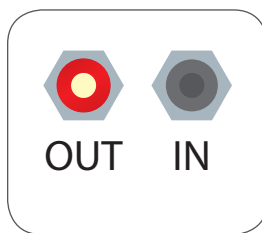

- POF Connection Port**
- Polymer Optical Fiber
  - Installed in controller and devices
  - Full intensity light

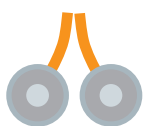

- GOF**
- Glass Optical Fiber
  - Orange cable
  - You can't see the light by eyes

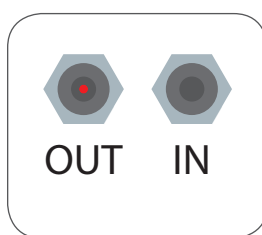

- GOF Connection Port**
- Glass Optical Fiber
  - Installed in controller and devices
  - Small thin red point which is difficult to see by eyes

**COMBINATIONS:**

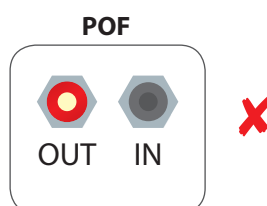
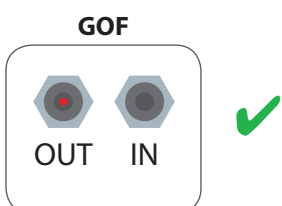
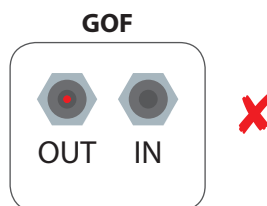
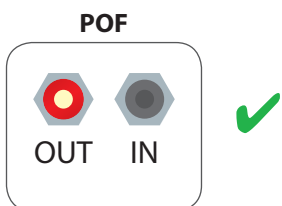

**IMPORTANT:** Please install covers on the ports, which are not in use

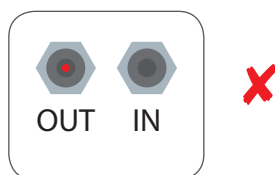
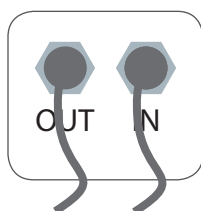
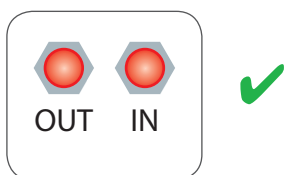
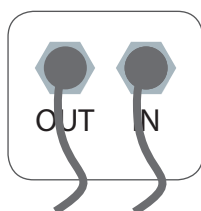





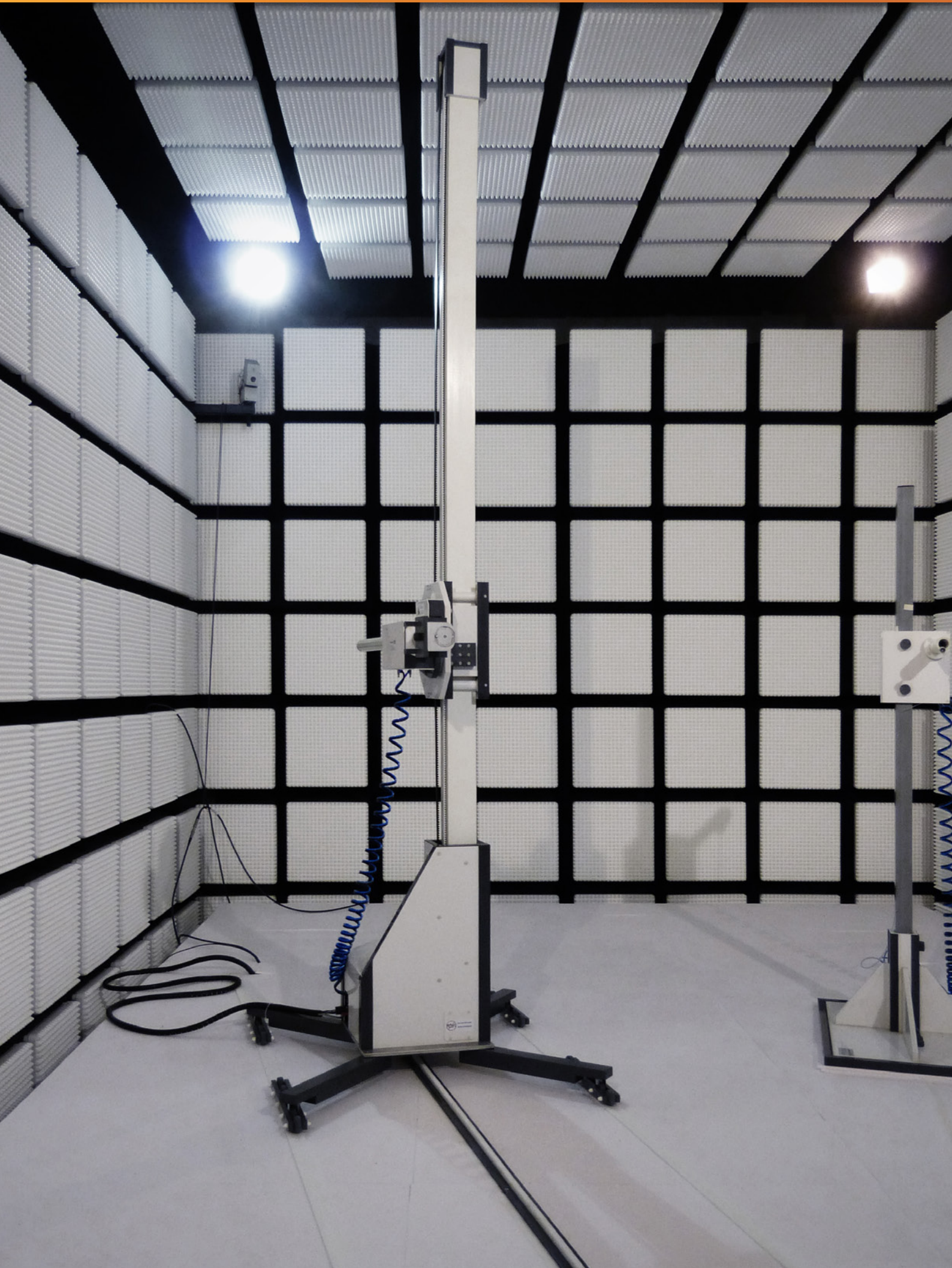

## | 8 | POSITIONING SYSTEMS

innco systems positioning systems are developed, designed and manufactured by our experienced and highly qualified engineering team, which enables a wide range of possibilities to design positioning systems according to your specifications or measurement applications.

The control of the system, singular or complex can be realized with our standard CO 3000 Controller, which allows connections to your measurement systems by GPIB or LAN.

## | 8.1 | PRODUCT OVERVIEW

### ABSORBING CLAMP POSITIONERS (KMS)

- Measuring length in: 5300, 5400, 6000 or 6100 mm
- Measuring height: 800 mm
- Slider unlockable and manually movable



### FIELD PROBE POSITIONERS (FSM)

- For 16 point measurement according to EN61000-4-3
- Max. load 2 kg



### MAST POSITIONERS (MP)

- Movement range from 1500 to 10000 mm
- Movement of: antenna stand, antenna mast & twin mast



### MAST ROTATORS (MR)

- For 125 kg and 250 kg mast weight
- In 200° and 400° turning range



### WALL POSITIONERS (WP)

- In electric or pneumatic polarisation
- Antenna weight up to 6 kg
- For measurement at fixed height



### VSWR POSITIONERS

- Up to 15000 mm movement range
- Manual or automatic mast rotation
- Antenna weight max. 10 kg







## | 8.2 | ABSORBING CLAMP POSITIONERS (KMS)

The KMS cable measuring slide bar construction is 100 % metal free, excepting the drive unit, which is located 430 mm from ground level. Used materials are mainly PVC & fiber glass reinforced plastic to keep high stability during frequently usage.

The universal clamp tray will fit for all commercially available measuring clamps. Limit switches and the general mechanical design ensure a reliable system operation.

New features are:

- Integrated roller & stopper for easy storage and setup
- Lockable clamp tray for manual movement of the slider

The GPIB (IEEE 488) & LAN (TCP/IP) bus, when operated with the CO 3000 Controller, provides an additional control option for all functions.

### SLIDE BARS (KMS)

Type	Description	Article No.
KMS5300	Moving range 5300 mm, clamp trolley at 800 mm	80004994
KMS5400	Moving range 5400 mm, clamp trolley at 800 mm	80006713
KMS6000	Moving range 6000 mm, clamp trolley at 800 mm	80000351
KMS6100	Moving range 6100 mm, clamp trolley at 800 mm	80000350

### ACCESSORIES

Description	Article No.
Secondary tray for slide bar	80004713

### SCOPE OF DELIVERY

Type	Quantity
Interface to CO 3000	1 x
Power supply cable	1 x 5 m
Integrated roller & stopper for easy storage and setup	1 set
Un-lockable clamp trolley for manual movement of the slider	1 x
Fiber optic cable	1 x 5 m, 1 x 10 m
FSMA	2 x
Operating manual	1 x

TECHNICAL DATA			
TYPE	KMS5300	KMS5400	KMS6000
Measuring length	min. 5300 mm	min. 5400 mm	min. 6000 mm
Total length	max. 6400 mm	max. 6500 mm	max. 6900 mm
Height	800 mm		
Material	PVC + fiber glass, weatherproof		
KMS cross-section	100 x 100 mm		
Base L x W	300 x 300 mm, 3 supporting pillars		
Positioning speed adjustable between	min. 1 m / 35 sec, max. 1 m / 5 sec		
Positioning accuracy	± 5 mm		
Slide bar drive	1 toothed belt		
Motor	electronic EC motor 150 W		
Control	microcontroller		
Interface	CAN Bus via fiber optics		
Control cable	fiber optic (polymer type)		
Operating voltage	115 V / 230 V, 50 / 60Hz		
Current consumption	max. 1.6A		
Temperature range	+8 °C...+40 °C		
TYPE	KMS6100		
Measuring length	min. 6100 mm		
Total length	max. 7000 mm		
Height	800 mm		
Material	PVC + fiber glass, weatherproof		
KMS cross-section	100 x 100 mm		
Base L x W	300 x 300 mm, 3 supporting pillars		
Positioning speed adjustable between	min. 1 m / 35 sec, max. 1 m / 5 sec		
Positioning accuracy	± 5 mm		
Slide bar drive	1 toothed belt		
Motor	electronic EC motor 150 W		
Control	microcontroller		
Interface	CAN Bus via fiber optics		
Control cable	fiber optic (polymer type)		
Operating voltage	110 / 230 V (50 / 60 Hz)		
Current consumption	max. 1.6A		
Temperature range	+8 °C...+40 °C		





### | 8.3 | FIELD PROBE POSITIONERS (FSM)

The Field Probe Positioner FSM 2315 is a two axis positioner for continuous or step by step movement according to EN61000-4-3 measurement. The movement range covers an area of 1.5 x 1.5 m.

Metal parts are used as less as possible and located in the drive unit only (max. 0.32 m above ground level). Limit switches and the general mechanical design ensure a reliable system operation.

The GPIB (IEEE 488) & LAN (TCP/IP) bus, when operated with the CO 3000 Controller, provides an additional control option for all functions.

#### FIELD PROBE POSITIONERS (FSM)

Type	Description	Article No.
FSM2315	Movement range 1500 x 1500 mm, max. load 2 kg	80000265
FSM2315-D	Movement range 1900 x 1500 mm, max. load 2 kg, dismountable for transport & storage	80002265

#### ACCESSORIES

Description	Article No.
Transport case for storing / shipping	80005819
Manual movement for FSM 2315 (without drive unit)	80004929

#### SCOPE OF DELIVERY

Type	Quantity
Interface to CO 3000 (FSM2315)	1 x
Interface to CO 3000 (FSM2315-D)	2 x
Power supply cable	1 x 5 m
Fiber optic cable (FSM2315)	1 x 5 m, 1 x 10 m
Fiber optic cable (FSM2315-D)	2 x 5 m, 2 x 10 m
FSMA (FSM2315)	2 x
FSMA (FSM2315-D)	4 x
Operating manual	1 x



TECHNICAL DATA		
TYPE	FSM2315	FSM2315-D
Sensor height (Z-axis)	800...2300 mm (adapter for other ranges available)	510...2410 mm
Horizontal movement (Y-axis)	1500 mm	
Total height	2650 mm	2500 mm
Probe fixing	1/4"-20 UNC	
Material	PVC, GFK, Kömacel®, POM	PVC, Kömacel®, fiber glass, polyamid
Overall dimensions	800 x 2240 mm	400 x 1933 mm
Sensor weight	max. 2 kg	
Position speed	max. 12 cm / sec	
Position accuracy	± 5 mm	
Movement of sensor	by toothed belts (Kevlar® cord reinforced)	
Motor	EC motor 150 W	
Control	microcontroller board	
Control line connection	fiber optic (polymer type)	
Drive unit	shielded and radio interference suppressed 20 dB under Class B	
Operating voltage	230 V 50 / 60 Hz (optional 110 V)	
Current consumption	max. 1.6 A	
Temperature range	+8 °C...+40 °C	

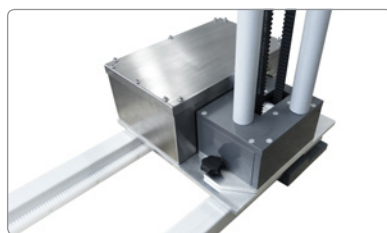
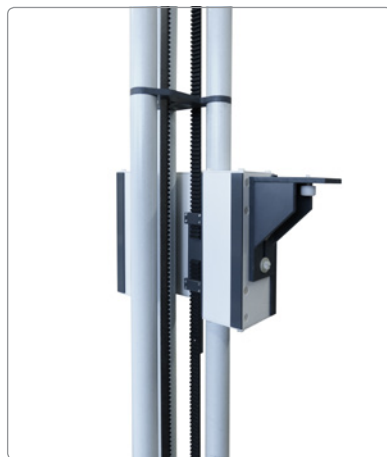



## | 8.4 | MAST POSITIONERS (MP)

The mast positioners are designed to move antenna masts with weights up to 80 kg / 175 lbs. They can be used in many ways for:

- automatic and accurate positioning of antenna masts when using different antennas with different reference distances
- automatic movement to minimise the influence of not used antennas / masts when measuring is done with two antennas sequentially
- NSA and VSWR / site VSWR measuring procedure (in combination with antenna mast)

The device is easy to install. Metal parts are minimised and located only at the drive (height 250 mm) behind the antenna.

The GPIB (IEEE 488) & LAN (TCP/IP) bus, when operated with the CO 3000 Controller, provides an additional control option for all functions.

### MAST POSITIONERS (MP)

Type	Description	Article No.
MP2000	2000 mm movement range, max. load 80 kg	80002033
MP2500	2500 mm movement range, max. load 80 kg	80007017
MP3000	3000 mm movement range, max. load 80 kg	80007159

### ACCESSORIES

Type	Description	Article No.
-VSWR	VSWR upgrade kit for regular mast on mast positioner	80007076

### SCOPE OF DELIVERY

Type	Quantity
Interface to CO 3000	1 x
Power supply cable	1 x 5 m
Fiber optic cable	2 x 5 m, 1 x 10 m
FSMA	2 x
Operating manual	1 x

TECHNICAL DATA			
TYPE	MP2000	MP2500	MP3000
Horizontal movement range (electric)	2000 mm	2500 mm	3000 mm
Material	plastics (except the drive)		
Working length	2000 mm	2500 mm	3000 mm
Overall length	2420 mm	2920 mm	3420 mm
Max. load	80 kg		
Positioning speed	approx. 5 cm / sec		
Positioning accuracy	± 1 mm		
Motor	electronic EC motor 150 W		
Control	microcontroller		
Control cable	fiber optic (polymer type)		
Drive unit	shielded and radio interference suppressed 20 dB under Class B of CISPR22		
Operating voltage	110 / 230 V (50 / 60 Hz)		
Temperature range	+8 °C...+40 °C		





## | 8.5 | MAST ROTATOR (MR)

The mast rotator MR0125 is designed to turn the antenna masts with weights up to 250 kg.

The MR0125 can be used in many ways for:

- automatic and accurate positioning of antenna masts when using different antennas with different reference distances
- automatic movement to minimise the influence of not used antennas / masts when measuring is done with two antennas sequentially
- save time for the operator & measurement. Antenna change is not necessary during frequency change.

The device is easy to install. Metal parts are minimised and located only at the drive (height 250 mm) behind each antenna.

The GPIB (IEEE 488) & LAN (TCP/IP) bus, when operated with the CO 3000 Controller, provides an additional control option for all functions.

MAST ROTATOR (MR)		
Type	Description	Article No.
MR0125	max. load 125 kg, 200° turning range	80005743
MR0250	max. load 250 kg, 200° turning range	80005745

ACCESSORIES	
Description	Article No.
400° turning range for MR0125	80005743
400° turning range for MR0250	80005744

SCOPE OF DELIVERY	
Type	Quantity
Interface to CO 3000	1 x
Power supply cable	1 x 5 m
Fiber optic cable	1 x 5 m, 1 x 10 m
FSMA	2 x
Operating manual	1 x

TECHNICAL DATA

TYPE	MR0125	MR0250
Total height	standard mast height will not increase	
Max. load	125 kg	250 kg
Rotating angle	-10° to +190° (-20° to +380° on request)	
Positioning speed	0.26 to 1.3 rpm	
Positioning accuracy	± 0.5°	
Motor	electronic EC motor 150 W	
Control	microcontroller	
Control cable	fiber optic (polymer type)	
Drive unit	shielded and radio interference suppressed 20 dB under Class B of CISPR22	
Operating voltage	110 / 230 V (50 / 60 Hz)	
Temperature range	+8 °C...+40 °C	





## | 8.6 | WALL POSITIONERS (WP)

The WP positioners are specifically designed to be mounted on chamber wall for measurements in electromagnetic absorption chambers at a fixed measuring height & distance. The construction is completely free of metal (except the drive unit). The enclosed DC motor, controlled via a fiber optic cable, is used during polarisation. Adjustable limit switches at end position enable a security feature.

The GPIB (IEEE 488) & LAN (TCP/IP) bus, when operated with the CO 3000 Controller, provides an additional control option for all functions.

### WALL POSITIONERS (WP)

Type	Description	Article No.
WP0500-EP	500 mm distance to the wall, 6 kg antenna weight	80007007
WP0600-EP	600 mm distance to the wall, 6 kg antenna weight	80007165

### ACCESSORIES

Type	Description	Article No.
-PP	Optional pneumatic polarisation	80004906
-MT	Optional manual tilt bore sight (only with -PP)	80000337

### SCOPE OF DELIVERY

Type	Quantity
Interface to CO 3000	1 x
Power supply cable	1 x 3 m
Fiber optic cable	1 x 5 m, 1 x 10 m
FSMA	2 x
Operating manual	1 x



TECHNICAL DATA		
TYPE	WP0500-EP	WP0600-EP
Antenna height fixed at	customer defined position	
Distance from antenna centre to the wall	500 mm	600 mm
Distance from positioning device to the wall	400 mm	500 mm
Material	PVC, Kömacel® & fiber glass, weatherproof	
Needed space on the wall H x W	550 mm x 500 mm	
Antenna weight	max. 6 kg (at the end of antenna pipe)	
Polarisation	0° / 90° (vert. / hor.)	
Polarisation time 0° / 90°	approx. 4 sec	
Polarisation drive	DC motor via gear drive	
Control	microcontroller board	
Control cable	fiber optic (polymer type)	
Total weight	17 kg	18 kg
Operating voltage	230 V 50 / 60Hz (optional 110 V)	
Current consumption	1.25 A	
Temperature range	+8 °C...+40 °C	





## | 8.7 | VSWR POSITIONERS

The VSWR linear positioner is designed to support the automatization of VSWR / and site VSWR measuring procedures with antennas up to 10 kg. The slide can be moved horizontally via innco systems standard controller OR if equipped with PC-option directly by PC. The signal is transmitted via fiber optic cable. An energy chain supports the antenna cable the whole measurement distance. The height of the antenna is manually adjustable. Most horn antennas can be polarised.

The mast beam can be rotated vertically excentric so the rotation axis is optimised according to the antenna center. The device is easy to move by lockable rollers. Metal parts are located only in the base plate and the drive mechanism (max. 0.4 m above ground level).

The GPIB (IEEE 488) & LAN (TCP/IP) bus, when operated with the CO 3000 Controller, provides an additional control option for all functions.

VSWR POSITIONERS		
Type	Description	Article No.
VSWR1500-MP	Moving range 1500 mm, 3 kg load MP= Manual Polarisation	80004937
VSWR4000-MP	Moving range 4000 mm, 5 kg load	80006785
VSWR15000-MP	Moving range 15000 mm, 10 kg load	80005697

ACCESSORIES		
Type	Description	Article No.
-MR	Mast section rotatable	80006813
-M	Manual positioning for VSWR (no drive unit)	80004938

SCOPE OF DELIVERY	
Type	Quantity
Interface to CO 3000	1 x
Power supply cable	1 x 5 m
Fiber optic cable	1 x 15 m
Operating manual	1 x

TECHNICAL DATA			
TYPE	VSWR1500-MP	VSWR4000-MP	VSWR15000-MP
Horizontal movement range (electric)	1500 mm	4000 mm	15000 mm
Antenna height (manually adjustable)	800...2300 mm	800...2300 mm	800...2500 mm
Total mast height	max. 2200 mm	max. 2600 mm	max. 2800 mm
Polarisation	manually		
Numbers of segments	1 pc.	2 pcs.	7 pcs.
Size of segments	800 mm x 2860 mm	2750 m x 900 mm	2357 mm x 800 mm
Mast section rotatable	0...360° (manually)	0...360° (by drive)	-
Material	PVC + GFK, weatherproof		
Mast cross-section	60 mm x 60 mm	60 mm x 60 mm	100 mm x 100 mm
Base L x W	800 mm x 2860 mm	900 mm x 5500 mm	800 mm x 16500 mm
Antenna weight (extended load on request)	max. 3 kg	max. 5 kg	max. 10 kg
Positioning speed adjustable between	1 to 12 cm / sec (15 or 20 cm / sec available)		
Positioning accuracy	better $\pm 3$ mm		
Driven by	toothed belt (Kevlar® cord reinforced)	rack track (metal free)	rack track (metal free)
Motor	electronic EC motor 150 W		
Control	microcontroller		
Control cable	fiber optic (polymer type)		
Drive unit	shielded and radio interference suppressed 20 dB under Class B of CISPR22		
Operating voltage	110 / 230 V (50 / 60Hz)		
Temperature range	+8 °C...+40 °C		

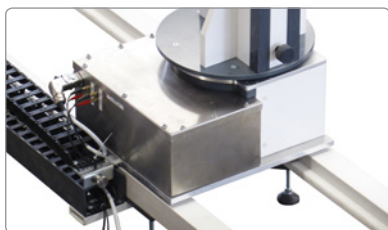



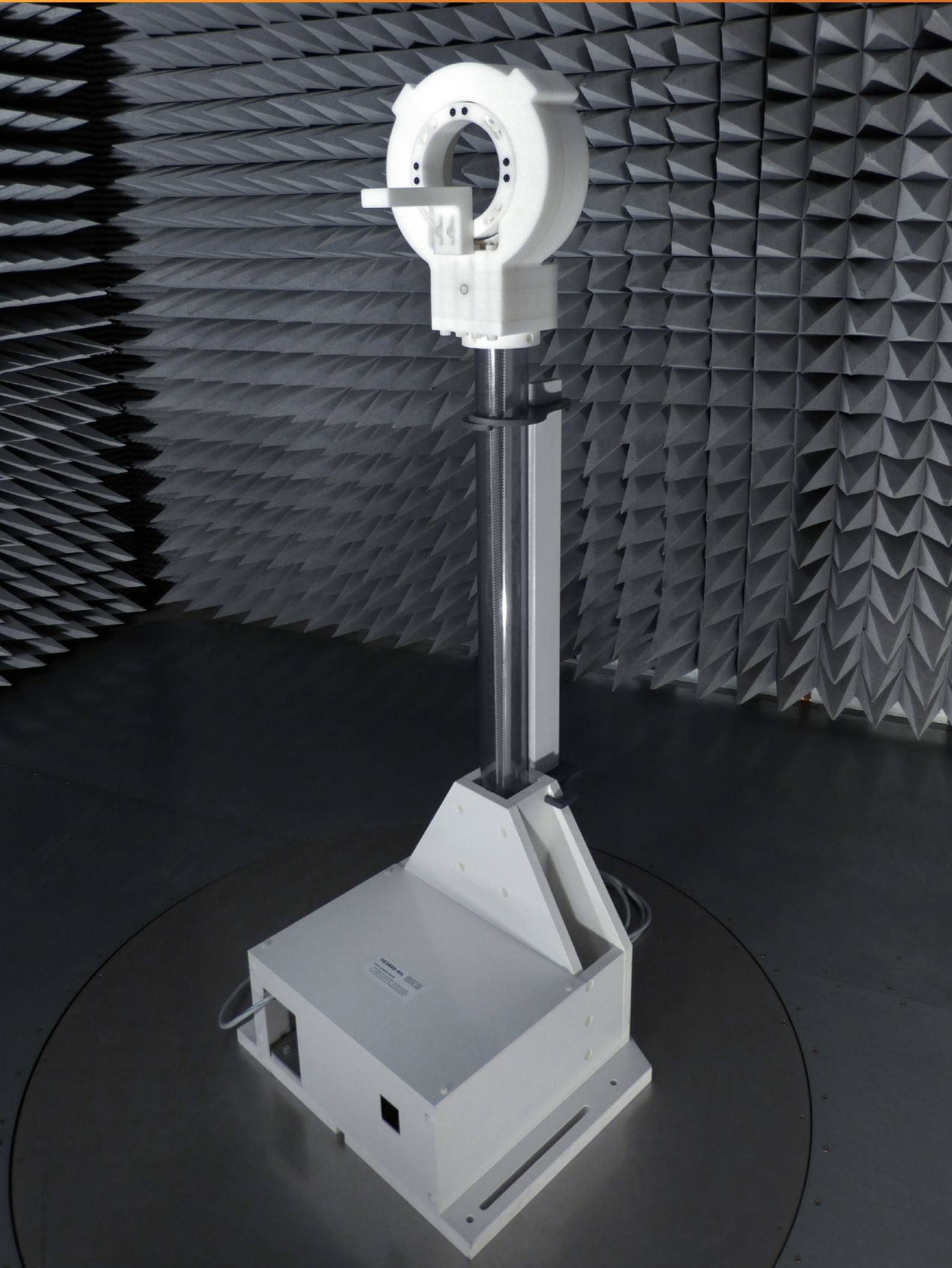



## | 9 | TURNDEVICES

Measurement systems for mobile phones, laptops, tablets and other specific electronic equipment, can be achieved using hi-tech materials, such as Rohacell® (as used in aerospace industry). incco systems 2D and 3D positioning systems are custom designed to meet each new challenge, for mobile phones to wireless network equipment.

The ultra-low permittivity of the materials used, ensures that no distortion of measurement accuracy will be seen during testing.

incco systems have designed and developed a number of unique positioning systems such as Tire-Pressure-Sensors-Positioner and SAR systems.



## | 9.1 | PRODUCT OVERVIEW

### TURNDEVICE (DE)

- Head material Rohacell®
- Up to 10 kg load
- Various holders for EUTs



### COMBINED TURNDEVICE (DK)

- Turning plat made of Rohacell®
- Up to 5 kg load
- Two turning axis





## | 9.2 | TURNDEVICES (DE) – DE3250-E

The DE 3250-E light duty turn device is specifically designed for measurements of medium sized equipment with cable assembly. With the exception of the drive only plastic and Rohacell® components are used. The turning plate is equipped with holes and fixing bolts, cables and equipment can be mounted within the rotating axis.

The turn device DE 3250-E exists of a steady bottom plate containing the drive unit, which is preferably fixed on a support table.

The GPIB (IEEE 488) & LAN (TCP/IP) bus, when operated with the CO 3000 Controller, provides an additional control option for all functions.

TURNDEVICES (DE)		
Type	Description	Article No.
DE3250-E	Plate size 500 x 300mm, height of turning axis 325 mm, max. load 3 kg	80006669

ACCESSORIES		
Type	Description	Article No.
-P	Pneumatic operation (0° or 90°)	80005795
Spare Plate	Rohacell® turning plate	80500196

SCOPE OF DELIVERY	
Type	Quantity
Interface to CO 3000	1 x
Power supply cable	1 x 3 m
Fiber optic cable	1 x 5 m, 1 x 10 m
FSMA	2 x
Operating manual	1 x

TECHNICAL DATA

TYPE	DE3250-E
Total height of rotation axis (above base plate)	325 mm
Total weight approx.	15 kg
Max. load	3 kg
Material	Rohacell®, Kömacel®, PVC
Positioning accuracy	± 1°
Rotating angle	0°...360°
Rotating time	max. 1.5 rpm
Driven by	toothed belt (Kevlar® cord reinforced)
Motor	electronic DC motor
Control	microcontroller
Drive unit	shielded and radio interference suppressed 20 dB under Class B
Operating voltage	230 V 50 / 60Hz (optional 110 V)
Current consumption	max. 1.6 A
Temperature range	+8 °C...+40 °C





## | 9.2 | TURNDEVICES (DE) – DE3330-RH

The DE3330-RH light duty turn device is specifically designed for measurements of medium sized equipment with cable assembly. With the exception of the drive only plastic and Rohacell® components are used. The turning plate is equipped with holes and fixing bolts, cables and equipment can be mounted within the rotating axis.

The turn device DE 3330-RH exists of a steady bottom part containing the drive unit, which is preferably fixed on a turntable. The distance of the lower part to the turntable centre is manually adjustable by longholes.

The GPIB (IEEE 488) & LAN (TCP/IP) bus, when operated with the CO 3000 Controller, provides an additional control option for all functions.

TURNDEVICES (DE)		
Type	Description	Article No.
DE3330-RH	Plate dimension 1200 x 1700 mm, height of turning axis: 1500 mm, max. load 2 kg	80004986

ACCESSORIES		
Type	Description	Article No.
-HP	High precision positioning (0.1 °)	80004898

SCOPE OF DELIVERY	
Type	Quantity
Interface to CO 3000	1 x
Power supply cable	1 x 3 m
Fiber optic cable	1 x 5 m, 1 x 10 m
FSMA	2 x
Operating manual	1 x

TECHNICAL DATA	
TYPE	DE3330-RH
Height over turntable	1702 mm
Total weight approx.	70 kg
Max. load	2 kg
Material	Rohacell®, POM, Kömacel®
Positioning accuracy	± 1°
Rotating angle	-15°...385°
Rotating time	max. 2.3 rpm
Driven by	toothed belt (Kevlar® cord reinforced)
Motor	motor 150 W
Control	microcontroller
Drive unit	shielded and radio interference suppressed 20 dB under Class B
Operating voltage	110 / 230 V (50 / 60Hz)
Current consumption	max. 1.6 A
Temperature range	+8 °C...+40 °C



## | 9.2 | TURNDEVICES (DE) – DE3600-RH

The DE 3600-RH light duty turn device is specifically designed for measurements of mobile phones and small antennas. With the exception of the drive unit are only plastic & Rohacell® components used. Different sized mobile phones or antennas can be mounted and adjusted within the rotating axis.

The turn device DE 3600-RH exists of a steady bottom part containing the drive unit, which is preferably fixed on a turntable. The distance of the lower part to the turntable centre is manually adjustable by longholes.

The GPIB (IEEE 488) & LAN (TCP/IP) bus, when operated with the CO 3000 Controller, provides an additional control option for all functions.

TURNDEVICES (DE)		
Type	Description	Article No.
DE3600-RH	Mobile phone positioner, height of turning axis 1500 mm, 2 kg load	80000145

ACCESSORIES		
Type	Description	Article No.
-HP	High precision positioning (0.1 °)	80004898
Holder 36-1	Universal horizontal mobile phone holder L = 240 with longhole	80004940
Holder 36-2	Universal vertical customer holder with longhole	80004941
Holder 36-3	Horizontal mobile phone holder L = 140 with longhole	80004942
Holder 36-4	Horizontal mobile phone holder L = 450 with longhole	80001219
Holder 36-5	Horizontal mobile phone holder L = 200 with longhole	80004943
Holder 36-6	Horizontal mobile phone and clamp holder L = 300 with longhole	80004944
Holder 36-7	Universal vertical phantom handholder with longhole	80004945
Holder 36-8	Universal horizontal mobile phone holder L = 200 with longhole	80004947

SCOPE OF DELIVERY	
Type	Quantity
Interface to CO 3000	1 x
Power supply cable	1 x 3 m
Fiber optic cable	1 x 5 m, 1 x 10 m
FSMA	2 x
Operating manual	1 x



TECHNICAL DATA

TYPE	DE3600-RH
Total weight approx.	40 kg
Max. load	2 kg
Material	Rohacell®, Kömacel®, PVC support pipe
Positioning accuracy	± 0.5°
Rotating angle	-15°...385°
Rotating time	max. 2.5 rpm
Driven by	toothed belt (Kevlar® cord reinforced)
Motor	electronic DC motor
Control	microcontroller
Drive unit	shielded and radio interference suppressed 20 dB under Class B
Operating voltage	110 / 230 V (50 / 60Hz)
Current consumption	max. 1.6 A
Temperature range	+8 °C...+40 °C

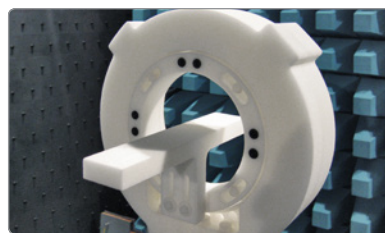



## | 9.2 | TURNDEVICES (DE) – DE3700-RH

The DE 3700-RH turn device is specifically designed for measurement of notebook pc, mobile phones with or without “artificial head”. With exception of the drive unit are only plastic & Rohacell® components used. Different sized mobile phones, “artificial heads” or laptops can be mounted on different additionally available holders.

The turn device DE 3700-RH exists of a steady bottom part containing the drive unit, which is preferably fixed on a turntable. The distance of the lower part to the turntable centre is manually adjustable by longholes.

The GPIB (IEEE 488) & LAN (TCP/IP) bus, when operated with the CO 3000 Controller, provides an additional control option for all functions.

TURNDEVICES (DE)		
Type	Description	Article No.
DE3700-RH	DUT positioner, height of turning axis 1500 mm, max. load 10 kg	80000144

ACCESSORIES		
Type	Description	Article No.
-HP	High precision positioning (0.1 °)	80004898
Holder 37-0	Mounting adapter for customer holder	80003799
Holder 37-1	Standard mobile phone holder (horizontal)	80003701
Holder 37-2	Universal vertical mounting plate	80003702
Holder 37-3	Universal plate with mobile phone holder and rotary joint	80003703
Holder 37-4	Laptop mounting plate 1000 x 500 mm (Rohacell®)	80003704
Holder 37-5	Laptop mounting plate 500 x 500 mm (Rohacell®)	80003705
Holder 37-6	Laptop mounting plate 800 x 500 mm (Rohacell®)	80003746
Holder 37-8	Tablet mounting plate 300 x 300 mm, height adjustable (Rohacell®)	80006732
Holder 37-9	Laptop mounting plate 500 x 500 mm with longholes and clamps (Rohacell®)	80006725
Holder 37-11	Laptop mounting plate 1000 x 500 mm with longholes and clamps (Rohacell®)	On request

SCOPE OF DELIVERY	
Type	Quantity
Interface to CO 3000	1 x
Power supply cable	1 x 3 m
Fiber optic cable	1 x 5 m, 1 x 10 m
FSMA	2 x
Operating manual	1 x

TECHNICAL DATA

TYPE	DE3700-RH
Total height	max. 1800 mm
Total weight approx.	40 kg
Max. load	10 kg
Material	Rohacell®, PVC transparent
Positioning accuracy	± 0.5°
Rotating angle	-15°...385°
Rotating time	max. 2.5 rpm
Driven by	toothed belt (Kevlar® cord reinforced)
Motor	EC motor 150 W
Control	microcontroller
Drive unit	shielded and radio interference suppressed 20 dB under Class B
Operating voltage	110 / 230 V (50 / 60Hz)
Current consumption	max. 1.6 A
Temperature range	+8 °C...+40 °C





## | 9.2 | TURNDEVICES (DE) – DE3800-RH

The DE 3800-RH turn device is specifically designed for measurement of notebook pc, mobile phones with or without “artificial head”. With exception of the drive unit are only plastic & Rohacell® components used. Different sized mobile phones, “artificial heads” or laptops can be mounted on different additionally available holders.

The turn device DE 3800-RH exists of a steady bottom part containing the drive unit, which is preferably fixed on a turntable. The distance of the lower part to the turntable centre is manually adjustable by longholes.

The GPIB (IEEE 488) & LAN (TCP/IP) bus, when operated with the CO 3000 Controller, provides an additional control option for all functions.

### TURNDEVICES (DE)

Type	Description	Article No.
DE3800-RH	DUT positioner, height of turning axis 1500 mm, max. load 10 kg	80004897

### ACCESSORIES

Type	Description	Article No.
-HP	High precision positioning (0.1 °)	80004898
Holder 38-1	Universal base mounting plate	80005101
Holder 38-2	Standard SAM HEAD holder	80005102
Holder 38-3	Standard mobile phone holder (fix hight)	80005103
Holder 38-4	Mobile phone holder (adjustable hight)	80005104
Holder 38-5	Laptop mounting plate 580 x 800 mm	80005105

### SCOPE OF DELIVERY

Type	Quantity
Interface to CO 3000	1 x
Power supply cable	1 x 3 m
Fiber optic cable	1 x 5 m, 1 x 10 m
FSMA	2 x
Operating manual	1 x

TECHNICAL DATA

TYPE	DE3800-RH
Total height	max. 1800 mm
Total weight approx.	40 kg
Max. load	10 kg
Material	Rohacell®, PVC transparent
Positioning accuracy	± 0.5°
Rotating angle	-15°...385°
Rotating time	max. 2.5 rpm
Driven by	toothed belt (Kevlar® cord reinforced) and gear wheel
Motor	electronic EC motor 150 W
Control	microcontroller
Drive unit	shielded and radio interference suppressed 20 dB under Class B
Operating voltage	110 / 230 V (50 / 60Hz)
Current consumption	max. 1.6 A
Temperature range	+8 °C...+40 °C





## | 9.2 | TURNDEVICES (DE) – DE3900-RH-50KG

The DE 3900-RH turn device is specifically designed for measurement of Tire Pressure Sensors. Therefore the whole tire with the rim could be mounted on the fiberglass turning axis by using the universal fixing kit. The center of the tire could be adjusted on the axle. An optionally available preparation-stand enables preparation of the EUT next to the turnunit. After preparation, the fixed tire could be lifted on the turndevice for the measurement.

With exception of the drive unit are only Rohacell® and plastic components used. The location of the drive unit is up to a height of 250 mm above floor level.

The turn device DE 3900-RH is mounted on a wooden base plate as bottom part containing the drive unit, which could be installed on a turntable. The used lockable rollers

enable a quick setup and storage of the device.

The GPIB (IEEE 488) & LAN (TCP/IP) bus, when operated with the CO 3000 Controller, provides an additional control option for all functions.

### TURNDEVICES (DE)

Type	Description	Article No.
DE3900-RH-50kg	Tire positioner, height of turning axis 1250 mm, max. load 50 kg	80005547

### ACCESSORIES

Type	Description	Article No.
-HP	High precision positioning (0.1 °)	80004898
GPR Axle	Spare axle l = 550 mm, up to 50 kg	80005774

### SCOPE OF DELIVERY

Type	Quantity
Interface to CO 3000	1 x
Power supply cable	1 x 3 m
Fiber optic cable	1 x 1 m, 1 x 5 m, 1 x 10 m
FSMA	4 x
Operating manual	1 x



TECHNICAL DATA

TYPE	DE3900-RH-50KG
Total height of turning axis (on customer request)	1250 mm
Total weight approx.	50 kg
Max. load	50 kg
Universal fixing kit for rim up to a width of	350 mm
Base L x W	1200 x 750 mm
Material	Rohacell®, POM, fiberglass
Positioning accuracy	± 0.5°
Rotating angle	0°...360°
Rotating time	max. 1.0 rpm
Driven by	toothed belt (Kevlar® cord reinforced) and gear wheel
Motor	EC motor 150 W
Control	microcontroller
Drive unit	shielded and radio interference suppressed 20 dB under Class B
Operating voltage	110 / 230 V (50 / 60Hz)
Current consumption	max. 1.6 A
Temperature range	+8 °C...+40 °C

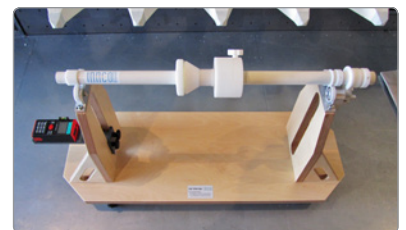
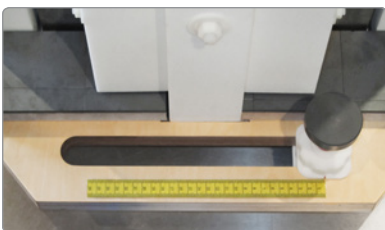
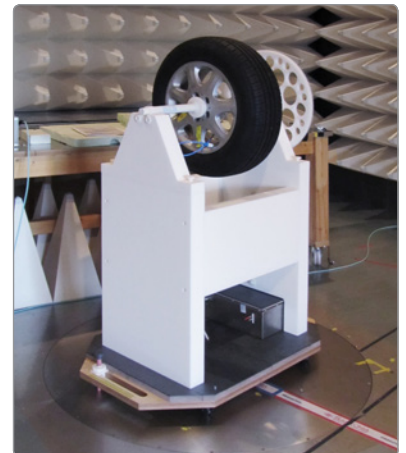



### | 9.3 | COMBINED TURNDEVICES (DK)

The DK is a combined positioner designed for automated record of spherical pattern in electromagnetic absorption chambers. The setup configuration is like the combined axis system described in the CTIA, the antenna needs only to change hor/vert orientation.

The shielded compact drive at the bottom (up to a height of approx. 30 cm) contains the motors for theta and phi axis rotation. All other parts are metal free to minimize the influence on the chamber.

Since both drives are located fix on the floor the DK can rotate endless in both axes.

A  $\varnothing$  60 mm hole in the centre of the drive can be used to route cables to the EUT.

The GPIB (IEEE 488) & LAN (TCP/IP) bus, when operated with the CO 3000 Controller, provides an additional control option for all functions.

COMBINED TURNDEVICES (DK)		
Type	Description	Article No.
DK3350	Combined positioner, two turning axes, max. load 5 kg	80007023
DK3820	Combined positioner, two turning axes, max. load 5 kg	80007175

ACCESSORIES	
Description	Article No.
Different sizes of the plate (all)	On request
Other heights (all)	On request
Rotary joint in the centre (all)	On request
Separate position feedback in realtime (all)	On request
110 V version (DK3350, DK3820)	On request
Fully Rohacell® structure (DK3350, DK3820)	On request
Grid on the plate (DK3350, DK3820)	On request
Rollers for easy movement (DK3820)	On request
Handles integrated in the structure (DK3820)	On request
Plastic structure (DK3880)	On request

SCOPE OF DELIVERY	
Type	Quantity
Power supply cable	1 x 5 m
Fiber optic cable (DK3350)	1 x 5 m, 1 x 15 m
Fiber optic cable (DK3820)	2 x 5 m, 2 x 15 m
FSMA (DK3350)	2 x
FSMA (DK3820)	4 x
Operating manual	1 x

TECHNICAL DATA		
TYPE	DK3350	DK3820
Height of turning axis	1500 mm <sup>1</sup>	
Permissible load	5 kg	
Material of the support plate	Rohacel	
Size of the support plate	500 × 300 mm <sup>1</sup>	300 × 300 mm <sup>1</sup>
Plate recessed to turning axis	25 mm*	adjustable 0 / 10 / 20 / 30 mm
Size of the base	ø 800 mm	ø 500 mm
Turning range and accuracy of ...		
... turndisc (horizontal / "theta axis" <sup>2</sup> )	endless / ± 1 °	
... turn device (horizontal / "phi axis" <sup>2</sup> )	endless / ± 1 °	
Rotation of both axles done	independent	
Rotation speed of turndisc / turn device	4 rpm / 1.5 rpm	4 rpm / 3 rpm
Motor	2 pcs. electronic EC motors (max. 150 W)	
Control	microcontroller	
Control line	fiber optic (polymer type)	
Drive unit	shielded and radio interference suppressed 20 dB below CISPR22 class B	
Operating voltage	230 V 50 / 60Hz (optional 110 V)	
Current consumption	approx. 2.8 A	
Temperature range	+8 °C...+40 °C	

<sup>1</sup> others on request

<sup>2</sup> acc. CTIA test plan







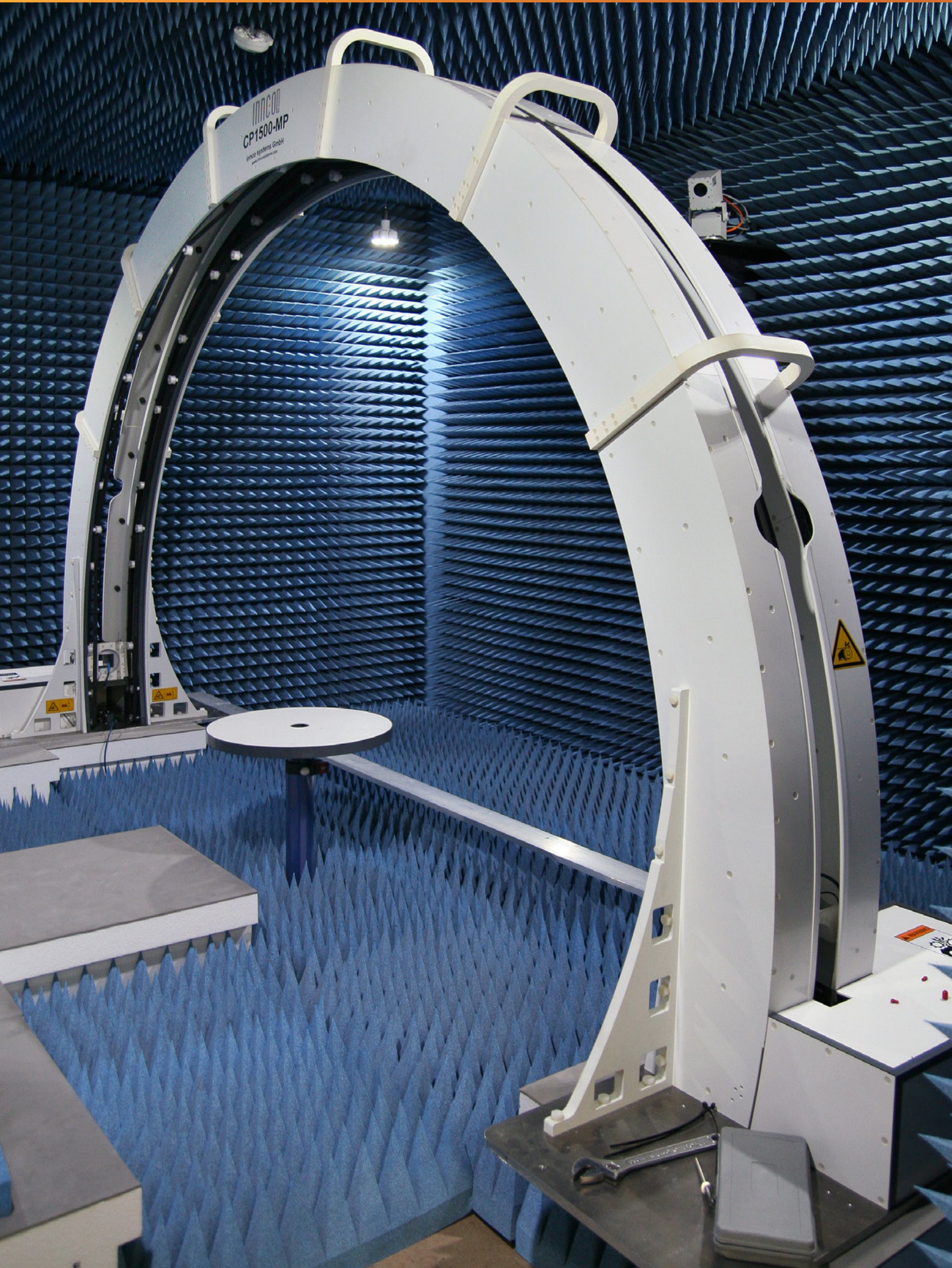



## | 10 | CUSTOMIZED POSITIONERS

The high qualified innco systems design team has huge capabilities to realize customer specific requests.

With more than 20 years' experience in development of positioning systems according to customer specification and new measurement standards / applications a large range of customized systems has been developed and manufactured.

innco systems use only the very best quality materials and the latest technological designs in its products.

The control of the system, singular or complex can be realized with our standard CO 3000 Controller, which allows connections to your measurement systems by GPIB or LAN.



## | 10.1 | PRODUCT OVERVIEW

### SWIVEL ARM ANTENNA POSITIONER (SAP)

- 1500...7000 mm radius
- Max. 220° turning range
- Up to 10 kg load



### HORIZONTAL POSITIONER (HP)

- 4500 mm moving range
- 1000 mm height adjustment
- Electro-pneumatic polarisation



### THREE AXIS POSITIONER (XYZ)

- Three axis positioning
- Metal free design
- Up to 2 kg load



### C-SHAPE ANTENNA POSITIONER (CP)

- 1500 mm radius
- Two independent movable trolleys, each 0.5 kg load



### TRANSMISSION RANGE MEASURING ROBOT (TRMR)

- 135 m moving range
- Pneumatic polarisation
- Internal battery for 30 h testing





## | 10.2 | SWIVEL ARM ANTENNA POSITIONERS (SAP)

The SAP Antenna Positioners are designed for atomised record of spherical antenna pattern in electromagnetic absorption chambers. The positioning system provides precise rotational positioning of antennas around vehicles or other EUT's.

AS-PP type the SAP is equipped with a pneumatic driven polarisation unit which is operated as separate device.

Adapters for all commercially available antennas are available. Special designs are available on request. All antennas rotate around their axis to eliminate elevation errors. Absolute value encoders on height and swing axis in combination with limit switches in

each direction and the general mechanical design ensure a reliable system operation.

The GPIB (IEEE 488) & LAN (TCP/IP) bus, when operated with the CO 3000 Controller, provides an additional control option for all functions.

### SWIVEL ARM ANTENNA POSITIONERS (SAP)

Type	Description	Article No.
SAP1500-PP-2kg-PP	1500 mm radius, 2 kg load PP= Pneumatic Polarisation	80004100
SAP5000-SL-10kg-PP	5000 mm radius, 10 kg load	80006627
SAP6000-SL-10kg-EP	6000 mm radius, 10 kg load	80006626

### ACCESSORIES

Description	Article No.
Electrical polarisation	On request
Degreewise polarisation electrical	On request
Manual polarisation	On request
Decreased / increased payload	On request
Other swivel radii	On request
Other heights	On request
Precise positioning ( $\pm 0.1^\circ$ )	On request
Holder for routing cables behind the drive	On request
110 V version	On request
Various adaptors	On request

### SCOPE OF DELIVERY

Type	Quantity
Fiber optic cable	1 x 5 m, 1 x 10 m
FSMA	2 x
Service unit for compressed air	1 x
Operating manual	1 x

TECHNICAL DATA			
TYPE	SAP1500-PP-2KG	SAP5000-SL-10KG-PP	SAP6000-SL-10KG-EP
Nominal swivel radius	1500 mm	5000 mm	6000 mm
Incl. free space until tip of polarisation rod of	200 mm	–	–
Working range in height	–	2500 mm	2500 mm
Antenna weight	max. 2 kg	max. 10 kg	max. 10 kg
Height of swivel axis1	800 / 1000 / 1200 / 1500 mm	–	–
Height requirement above rotation axis	2000 mm	–	–
Height speed adjustable	–	7.5 mm / s	7.5 mm / s
Swivel speed adjustable	0.1 ... 15° / sec	1.0° / sec	1.0° / sec
Size of base plate	650 x 850 mm	700 x 1000 mm	700 x 1000 mm
Material of arm	RFP	RFP with Rohacell® core	RFP with Rohacell® core
Other material except drive	RFP, PVC, Kömacel®, POM, PA, ... (all metal free)	RFP, PVC, Rohacell®, POM, PA, ... (all metal free)	RFP, PVC, Rohacell®, POM, PA, ... (all metal free)
Positioning accuracy	better ± 1°	± 0.5°	± 0.5°
Rotating angle	-110°...+110° OR -10...+190°	-90°...+90°	-90°...+90°
Polarisation	0 / 90°	0 / 90°	0...360°
Carried out	pneumatic	pneumatic	electric drive
Compressed air supply needed	min. 6 bar		
Control line	fiber optic (polymer type)		
Drive unit	shielded and radio interference suppressed 20 dB below CISPR22 class B		
Operating voltage	230 V 50 / 60Hz (optional 110 V or 400 V)		
Current consumption	approx. 1.6 A	max. 32 A	max. 32 A
Temperature range	+8 °C...+40 °C		

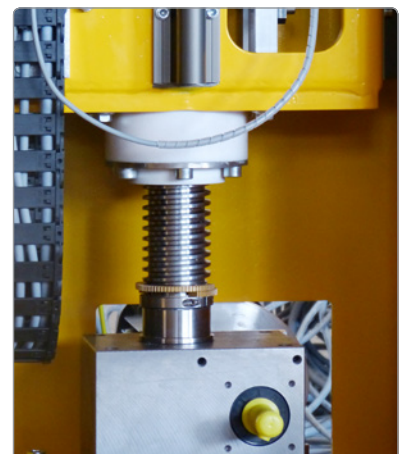



### | 10.3 | HORIZONTAL POSITIONERS (HP)

The HP4510-4kg is a horizontal positioner to move small antennas over absorber fields in electromagnetic absorption chambers. Two rails are placed between / in absorbers, with the drive moving the superstructure on main rail and support dolly on secondary rail for exact antenna movement in low tolerances and free from shivering,

A cable management capable for power and signals allows also flexible antenna cable. The height of the antenna can be adjusted by controller and also the antenna orientation (hor/vert).

Metal parts are only used for the shielded drive which is close to the floor and behind the antenna.

The GPIB (IEEE 488) & LAN (TCP/IP) bus, when operated with the CO 3000 Controller, provides an additional control option for all functions.

HORIZONTAL POSITIONERS (HP)		
Type	Description	Article No.
HP4510-4kg	4500 mm moving range, 1000 mm height adjustment, max. load 4 kg	80004202

ACCESSORIES	
Description	Article No.
Different moving ranges	On request
Heights	On request
Other payloads	On request
Pneumatic polarisation	On request

SCOPE OF DELIVERY	
Type	Quantity
Power supply cable	1 x 5 m
Fiber optic cable	2 x 5 m, 2 x 15 m
FSMA	4 x
Operating manual	1 x

TECHNICAL DATA

TYPE	HP4510-4KG
Height of antenna	1500 ... 2500 mm
Moving range and accuracy of ...	
... back / forward	electric, 4500 mm / $\pm 5$ mm
... up / down	electric, 1000 mm / $\pm 2.5$ mm
Permissible load	4 kg
Material of the structure	fiber glass, PVC, PC, PTFE, ... all non conductive
Total length / height	5990 mm / 2690 mm
Polarisation of the antenna	electro-pneumatic
Control	microcontroller
Control line	fiber optic (polymer type)
Drive unit	shielded and radio interference suppressed 20 dB below CISPR22 class B
Operating voltage	230 V 50 / 60Hz (optional 110 V)
Current consumption	approx. 3.6 A
Temperature range	+8 °C...+40 °C

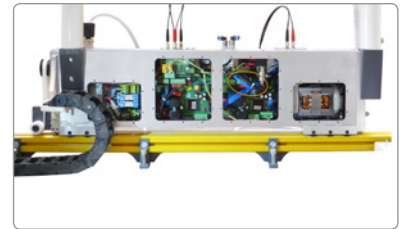



## | 10.4 | THREE AXIS POSITIONERS (XYZ) – XYZ120815

The 3 Dimensional Positioner XYZ120815 is designed to support the automation of RFID Transponder measuring in continues or step by step movement. The base is specifically designed for the size of a EURO-pallet 1200 x 800 mm (L x W)

All three axis can be operated independent and at the same time to shorten the measurement.

Metal parts are located only in the drive mechanism (max. 300 mm above ground level). Limit switches and the general mechanical design ensure a reliable system operation.

The GPIB (IEEE 488) & LAN (TCP/IP) bus, when operated with the CO 3000 Controller, provides an additional control option for all functions.

### THREE AXIS POSITIONERS (XYZ)

Type	Description	Article No.
XYZ120815	Three axis positioner, 2 kg load	80005609

### ACCESSORIES

Description	Article No.
Different moving ranges	On request
Other heights	On request
Separate position feedback in realtime	On request

### SCOPE OF DELIVERY

Type	Quantity
Interface to CO 3000	3 x
Power supply cable	1 x 5 m
Fiber optic cable	3 x 5 m, 3 x 15 m
FSMA	6 x
Operating manual	1 x



TECHNICAL DATA	
TYPE	XYZ120815
Height / width when moving	1500 mm / 1000 mm
Permissible load	2 kg
Material of the structure	fiber glass, PVC, PC, PTFE, ... all non conductive
Moving range and accuracy of ...	
... X-Axis (left/right)	700 mm / $\pm 5$ mm
... Y-Axis (back/forward)	1200 mm / $\pm 5$ mm
... Z-Axis (up/down)	1000 mm / $\pm 5$ mm
Repeatability of positioning	$\pm 2$ mm
Base (L x W)	1194 mm x 800 mm
Positioning speed	max. 5 cm/s
Polarisation of the antenna	manually
Control	microcontroller
Control line	fiber optic (polymer type)
Drive unit	shielded and radio interference suppressed 20 dB below CISPR22 class B
Operating voltage	230 V 50 / 60Hz (optional 110 V)
Current consumption	approx. 3.6 A
Temperature range	+8 °C...+40 °C

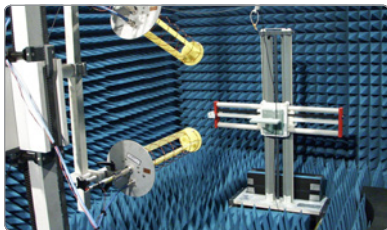



## | 10.4 | THREE AXIS POSITIONERS (XYZ) – XYZ 030503

The XYZ030503 is a movable positioner to move small antennas independent in three orthogonal axes. The complete design is made for using in electromagnetic absorption chambers.

A stable framework carries in its upper region the shielded drive which moves an antenna adaption plate made of foamed plastic. The gadget for polarisation can be used manually or as smart polarisation by moving a certain path. If equipped with vario frame the drive can change the position so that the antenna is scanning at the side of the EUT. In combination with a small turntable many areas/planes/sides (of EUTs surface) can be

covered/scanned without manual changes.

The GPIB (IEEE 488) & LAN (TCP/IP) bus, when operated with the CO 3000 Controller, provides an additional control option for all functions.

### THREE AXIS POSITIONERS (XYZ)

Type	Description	Article No.
XYZ 030503 Type C	Three axis positioner, 2 kg load	80006660
XYZ 030503 Type D	Three axis positioner, 2 kg load	80004660

### ACCESSORIES

Description	Article No.
Different moving ranges	On request
Other heights	On request
Separate position feedback in realtime	On request

### SCOPE OF DELIVERY

Type	Quantity
Interface to CO 3000	3 x
Power supply cable	1 x 5 m
Fiber optic cable	3 x 5 m, 3 x 15 m
FSMA	6 x
Operating manual	1 x

TECHNICAL DATA		
TYPE	XYZ 030503 TYPE C	XYZ 030503 TYPE D
Height / width when moving	1900 mm / 900 mm	
Permissible load	2 kg	
Material of the structure	fiber glass, PVC, PC, PTFE, ... all non conductive	
Material of the antenna adaption plate	–	foamed plastic
Moving range and accuracy of ...		
... X-Axis (left/right)	300 mm / ± 2.5 mm	300 mm / ± 1.5 mm
... Y-Axis (back/forward)	500 mm / ± 2.5 mm	500 mm / ± 1.5 mm
... Z-Axis (up/down)	300 mm / ± 2 mm	300 mm / ± 1.5 mm
Space to table <sup>1</sup>	500 ... 800 mm	500 ... 800 mm (others on request)
Base (L x W)	950 x 1160 mm	850 x 1350 mm
Range additionally adjustable	+700 mm (by polarisation tube) ... -1100 mm (by shifting on mast tube)	–
Distance from antenna to vertical pole	850 mm (with standard gibbet superstructure)	–
Positioning speed...		
... X-Axis (left/right)	14 mm/s	
... Y-Axis (back/forward)	14 mm/s	
... Z-Axis (up/down)	11 mm/s	
Polarisation of the antenna <sup>2</sup>	manually	manually and smart polarisation (by moving a defined path in max. height)
Control	microcontroller	
Control line	fiber optic (polymer type)	
Drive unit	shielded and radio interference suppressed 20 dB below CISPR22 class B	
Operating voltage	230 V 50 / 60Hz (optional 110 V)	
Current consumption	approx. 3.6 A	
Temperature range	+8 °C...+40 °C	

<sup>1</sup> is the space available for EUT and antenna – measured between downside of antenna adaption plate and EUT test table with 800 mm height      <sup>2</sup> optionally: pneumatic or electric





## | 10.5 | C-SHAPE ANTENNA POSITIONER (CP)

The CP1500-MP is an antenna positioner designed for automatised measurement of EUT reflection in electromagnetic absorption chambers. It features two independently controllable and radially movable carriages equipped with receptacles for small antennas. Along the theoretical connection line from -90° to +90°, the entire machine is made metal free. The positioner consists of guide sectors, two swivel carriages with aerial antenna holders and drives.

Two separately controllable drive units, each with a motor power of 150 W, drive the carriage via belt drive. They are located left and right of the positioner. Additionally equipped cable carriers enable a save guidance of the antenna cables.

The GPIB (IEEE 488) & LAN (TCP/IP) bus, when operated with the CO 3000 Controller, provides an additional control option for all functions.

C-SHAPE ANTENNA POSITIONER (CP)		
Type	Description	Article No.
CP1500-MP	1500 mm radius, two antenna trolleys, each 500 g load capacity	80006800

ACCESSORIES	
Description	Article No.
Different moving ranges	On request
Other heights	On request
Separate position feedback in realtime	On request

SCOPE OF DELIVERY	
Type	Quantity
Interface to CO 3000	2 x
Fiber optic cable	2 x 5 m, 2 x 10 m
FSMA	4 x
Operating manual	1 x

TECHNICAL DATA

TYPE	CP1500-MP
Nominal swivel radius	1500 mm
Height of middle axis for EUT	350 mm
Antenna weight	max. 2 x 0.5 kg
Size of base plate / each side (L x W)	485 x 920 mm
Swivel speed adjustable	0.19 ... 3.8 °/sec
Positioning accuracy	better ± 0.5
Rotating angle	-90°...+96°
Polarisation	0 / 90°
Carried out	manually
Compressed air supply needed	min. 6 bar
Control line	fiber optic (polymer type)
Drive unit	shielded and radio interference suppressed 20 dB below CISPR22 class B
Drive method	tooth RFP
Other material except drive	RFP, PVC, Kömacel®, POM, PA, ... - all metal free
Operating voltage	230 V 50 / 60Hz (optional 110 V)
Current consumption	approx. 2 x 1.6 A
Temperature range	+8 °C...+40 °C

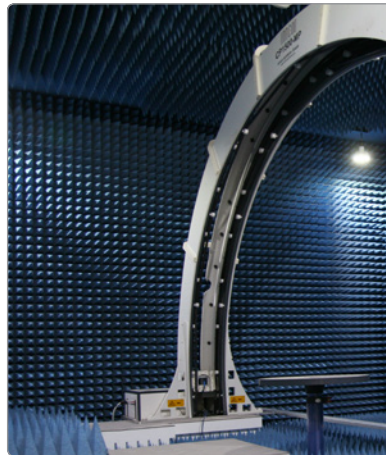
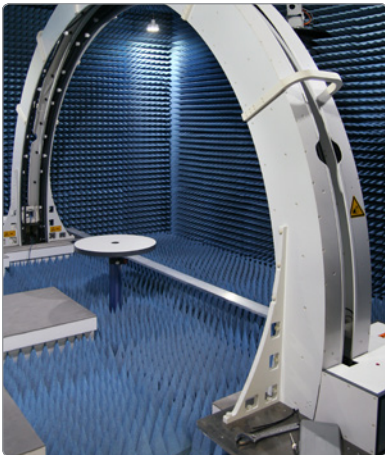



## | 10.6 | TRANSMISSION RANGE MEASURING ROBOT (TRMR)

The TRM130 Robot is designed for fully automatically measurement of radio transmitter keys for use in open areas. The integrated high power battery allows measurement without wires or metallic parts on the whole measurement range. The pneumatic driven key actuators (2pcs.) are adjustable to meet almost key dimensions. Adapter holders for specific key dimensions are available on request.

The usual installed phantom water body with key-actuator is easy replaceable by a manual height adjustable antenna stand with automatic pneumatic polarisation unit.

A guiding rail, which is made of weather proved fiberglass, can be installed outside of the measurement area, to enable an easy cleaning or different usage of the moving area.

Metal parts are located only in the drive unit, which is behind the antenna (max. 0.6 m above ground level).

Limit switches and the general mechanical design ensure a reliable system operation.

The GPIB (IEEE 488) & LAN (TCP/IP) bus, when operated with the CO 3000 Controller, provides an additional control option for all functions.

### TRANSMISSION RANGE MEASURING ROBOT (TRMR)

Type	Description	Article No.
TRMR130	Movement range of 130 m, with internal battery (no power supply cable needed)	80005561

### ACCESSORIES

Description	Article No.
Water body 80 liter volume	On request
Water arm 1.5 liter volume	On request
Phantom hand SPEAG (silicon-carbon mix)	On request
Antenna mast 2 m with pneumatic polarisation	On request
5 Port LAN switch	On request
GPIB to LAN converter	On request
Integrated compressor (8 bar)	On request
Charging unit (8 h charge time)	On request

### SCOPE OF DELIVERY

Type	Quantity
Interface to CO 3000	1 x
Fiber optic cable	1 x 140 m, 1 x 20 m
FSMA	2 x
Integrated Battery (220 Ah)	1 x
Charging unit (12 h charge time)	1 x
Integrated 230 V power supply (2000 W)	1 x



TECHNICAL DATA

TYPE	TRMR130
Movement Range	130 m
Cable length	max. 136 m
Positioning accuracy	< 1% of movement area
Speed	max. 5 km/h
Drive	500 W EC motor
Power supply	integrated gel / dry battery 12 V; 220 Ah for approx. 30 h usage
Customer Connectors	2 x 230 V, max. 2000 W
Polarisation	pneumatic
Antenna height	max. 2000 mm
Control	by CO 3000 Controller, handheld control unit by wire
Signal transmission	fiber optic laser, by multiplex method
Tires	6 pcs. air tires Ø 220 mm
Own weight	approx. 450 kg
Temperature range	-5 °C...+40 °C







## | 11 | TEST TABLES

innco systems Plastic Tables (PT) are lightweight, portable test tables, designed and manufactured with special materials for lowest possible dielectric properties and highest mechanical stability.

The used materials of the table top to support the DUT have a dielectric constant below 3.0.

Two materials of the table structure could be chosen: polystyrene or Rohacell® which have both a low dielectric constant (1.2 and 1.04). The benefit by using these materials is a test table, which has no influence on radiated emissions measurements, especially above 1 GHz, where the material is most important.

For an easy positioning of the DUT on the test tables a printed raster with 10 x10 cm helps to find the setup position. Optionally holes in the table top are helpful to guide the cables at a defined position.

PT Test Tables are available in various sizes and load capacities, also in special configuration with rollers or structure designs to fit onto the turntable below. Regarding your unique design, just contact us.

## | 11.1 | PRODUCT OVERVIEW

### PLASTIC TEST TABLE MADE OF POLYSTYRENE (PT-SD)

- Lightweight material
- Several standard sizes
- Up to 100 kg load



### PLASTIC TEST TABLE MADE OF ROHACELL® (PT-RH)

- Lightweight & strong material
- Several standard sizes
- Up to 120 kg load



### WOODEN TEST TABLE FOR CISPR 25 (WT)

- According to CISPR 25
- With single copper plate (2 mm)
- Wooden table structure

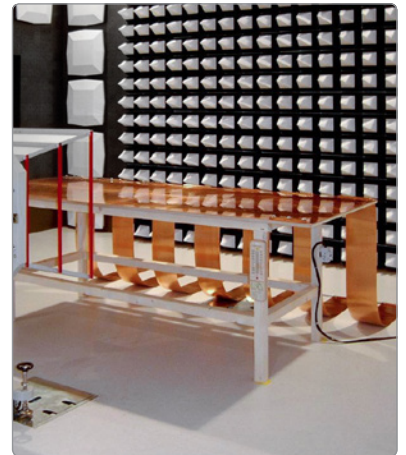

### PLASTIC TABLE FOR ROD ANTENNAS (HT)

- Fixing of monopole antenna
- Adjustable height
- Support of additional grounding plate





## | 11.2 | PLASTIC TEST TABLE MADE OF POLYSTYRENE (PT-SD)

The PT-SD Test Table is made of polystyrene, which is light-weight and therefore easy movable. Polystyrene provides a low dielectric constant of 1.2, in combination with the low price, this material is the most economical solution.

The removable table top cover plate protect the table surface from sharp edges of the DUTs.

PT-SD test tables are available in various sizes and load capacities, also in special configuration with rollers or structure designs to fit onto the turntable below. Regarding your unique design, just contact us.

### PLASTIC TEST TABLE MADE OF POLYSTYRENE (PT-SD)

Type	Description	Article No.
PT1208-SD	Material: polystyrene, 1200 x 800 mm, 100 kg load	80004972
PT1510-SD	Material: polystyrene, 1500 x 1000 mm, 100 kg load	80003971
PT2510-SD	Material: polystyrene, 2500 x 1000 mm, 100 kg load	80005557

### ACCESSORIES

Type	Description	Article No.
-PTP	Pertinax top plate, t = 1 mm	31000319
-HL	Higher load for PT-SD	On request
-IR	With installed rollers (only movable in unloaded condition)	On request

### SCOPE OF DELIVERY

Type	Quantity
Top cover plate	1 x



TECHNICAL DATA			
TYPE	PT1208-SD	PT1510-SD	PT2510-SD
<b>Material:</b>			
Structure	polystyrene		
Dielectric constant $\epsilon_r$ at 1 MHz	approx. 1.2		
Table top	pertinax t= 1 mm	PVC t= 2 mm	pertinax t= 1 mm
Dielectric constant $\epsilon_r$ at 1 MHz ca. 1.6	approx. 1.6	approx. 3.0	approx. 1.6
	table top plate removable	table top plate removable	table top cover plate removable
<b>Dimensions:</b>			
Height	800 mm (or 640 mm for DS-HA)	800 mm	800 mm
Table top	1200 mm x 800 mm	1500 mm x 1000 mm	2500 mm x 1000 mm
Load capability	100 kg		





### | 11.3 | PLASTIC TEST TABLE MADE OF ROHACELL® (PT-RH)

The PT-RH test table is made of Rohacell®, which is light-weight and therefore easy movable. Rohacell® provides a low dielectric constant of 1.04 in combination with a high mechanic stability.

The removable table top cover plate protect the table surface from sharp edges of the DUTs.

PT test tables are available in various sizes and load capacities, also in special configuration with rollers or structure designs to fit onto the turntable below. Regarding your unique design, just contact us.

#### PLASTIC TEST TABLE MADE OF ROHACELL® (PT-RH)

Type	Description	Article No.
PT1208-RH	Material: Rohacell®, 1200 x 800 mm, 120 kg load	80005295
PT1510-RH	Material: Rohacell®, 1500 x 1000 mm, 100 kg load	80005749
PT1810-RH	Material: Rohacell®, 1800 x 1000 mm, 120 kg load	80005580

#### ACCESSORIES

Type	Description	Article No.
-PTP	Pertinax top plate, t = 1 mm	31000319
-HL	Higher load for PT-RH	On request
-IR	With installed rollers (only movable in unloaded condition)	On request

#### SCOPE OF DELIVERY

Type	Quantity
Top cover plate	1 x

TECHNICAL DATA			
TYPE	PT1208-RH	PT1510-RH	PT1810-RH
<b>Material:</b>			
Structure	Rohacell®	Rohacell® IG. 31 or 51G	Rohacell® IG. 31 or 51G
Dielectric constant $\epsilon_r$ at 1 MHz	1.04		
Table top	pertainax t = 1 mm		
Dielectric constant $\epsilon_r$ at 1 MHz ca. 1.6	approx. 1.6		
Table top removable			
<b>Dimensions:</b>			
Height	800 mm		
Table top	1200 mm x 800 mm	1500 mm x 1000 mm	1800 mm x 1000 mm
Load capability	120 kg	100 kg	120 kg



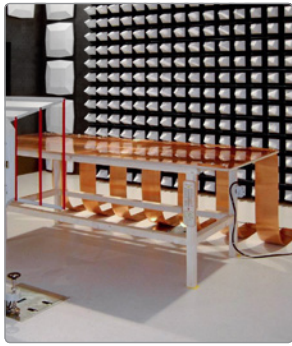

## | 11.4 | WOODEN TEST TABLES FOR CISPR 25 (WT)

The WT test tables are specifically designed for measurements according to CISPR 25 standard. The single copper plate on the top and the flexible grounding stipes ensure best connectivity to the chamber wall or to the floor.

The table could be equipped optionally with rollers for an easy movement and storage.

### WOODEN TEST TABLES FOR CISPR 25 (WT)

Type	Description	Article No.
WTT2510-900	CISPR 25 test table, made of wood, 2500 x 1000 mm, 300 kg load	80006654
WTT3510-900	CISPR 25 test table, made of wood, 3500 x 1000 mm, 300 kg load	80007167

### ACCESSORIES

Type	Description	Article No.
-HL	Higher load for WT	On request
-IR	With installed rollers (only movable in unloaded condition)	On request

### SCOPE OF DELIVERY

Type	Quantity
Single piece copper plate	1 x
Grounding stipes	1 set

TECHNICAL DATA		
TYPE	WTT2510-900	WTT3510-900
<b>Material:</b>		
Structure	wood (birch multiplex)	
Table top	copper t = 2 mm	
<b>Dimensions:</b>		
Height	900 mm	
Table top	2500 mm x 1000 mm	3000 mm x 1500 mm
Load capability	300 kg	



## | 11.5 | PLASTIC TABLE FOR ROD ANTENNAS (HT)

The HT0806-805 test table is specifically designed for measurements with a monopole rod-antenna, which could be fixed by 1/4-20 UNC screw on the table top.

The table height could be adjusted manually by hand crank or using cordless electric screwdriver. An installed scale indicates the actual table height.

The extendable support for the additional ground plate supports a groundplane up to 1300 mm length (incl. monopole antennas plate).

### PLASTIC TABLE FOR ROD ANTENNAS (HT)

Type	Description	Article No.
HT0806805	800 x 600 mm table plate, max. height 805 mm, max. load 15 kg	80005791

### ACCESSORIES

Description	Article No.
Spacer disc below antenna and mounting rails, to fix the antenna plate	80005793

### SCOPE OF DELIVERY

Type	Quantity
Operating manual	1 x



TECHNICAL DATA

TYPE	HT0806805
<b>Material:</b>	
Structure	PVC
Table top	Kömacel®
Spindle	fiberglass
<b>Dimensions:</b>	
Height manually adjustable	500...805 mm (height of table top)
Table top	800 mm x 600 mm
Load capability	15 kg







## | 12 | WALL MOUNTING BRACKETS

innco systems Wall Mounting Brackets are 100 % metal free and especially designed for EMC absorbtion chambers.

The stabile stucture is able to carry the camera and audio systems at the chamber wall.

Different bracket-lenghts are available to place the camera in front of the installed wall-absorbers.

Several adapter mounting plates for different camera and audio systems are available on request.

The installation could be done directly by screws on the wall or by clamps on the rail system of the chamber.

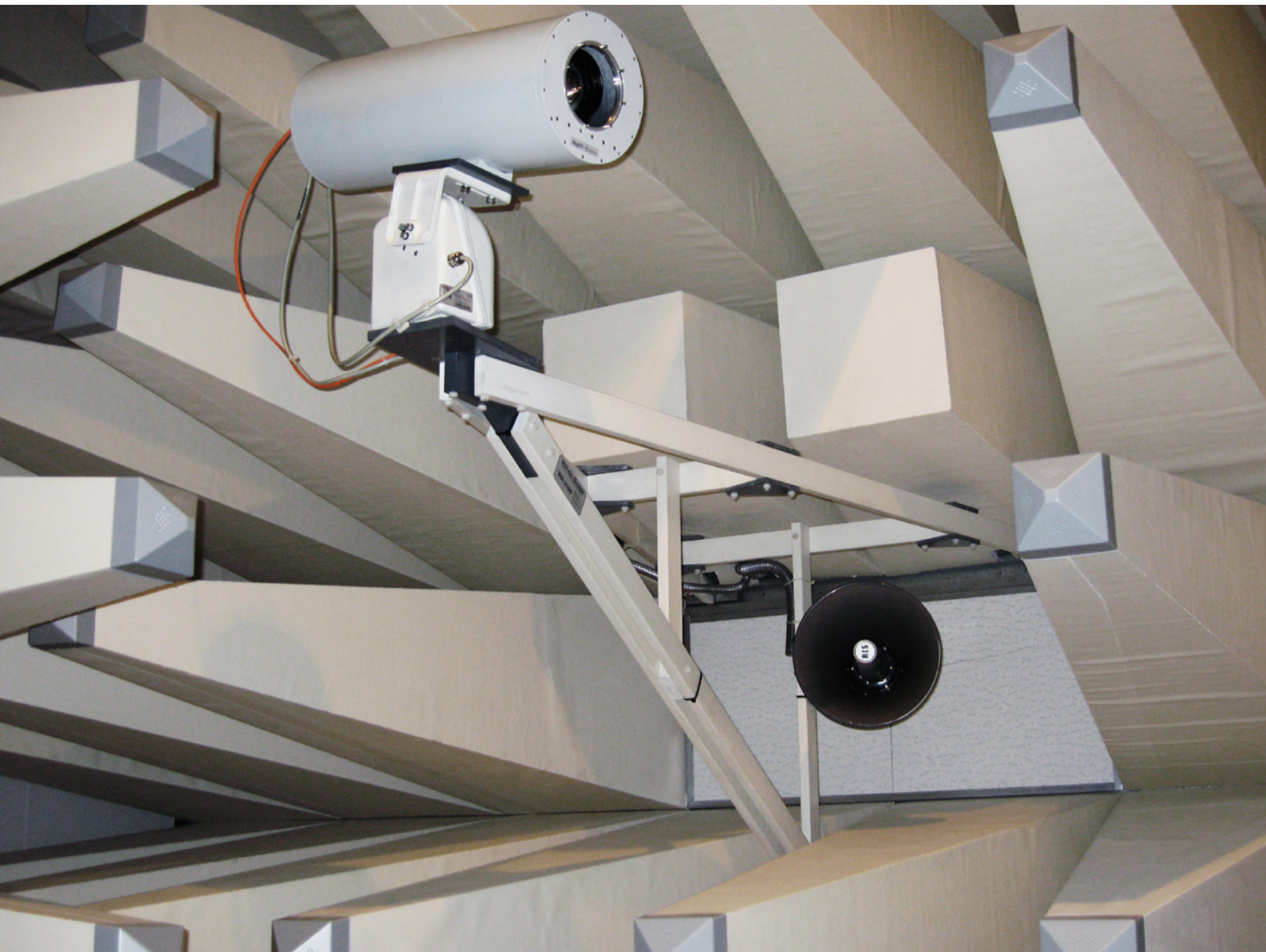





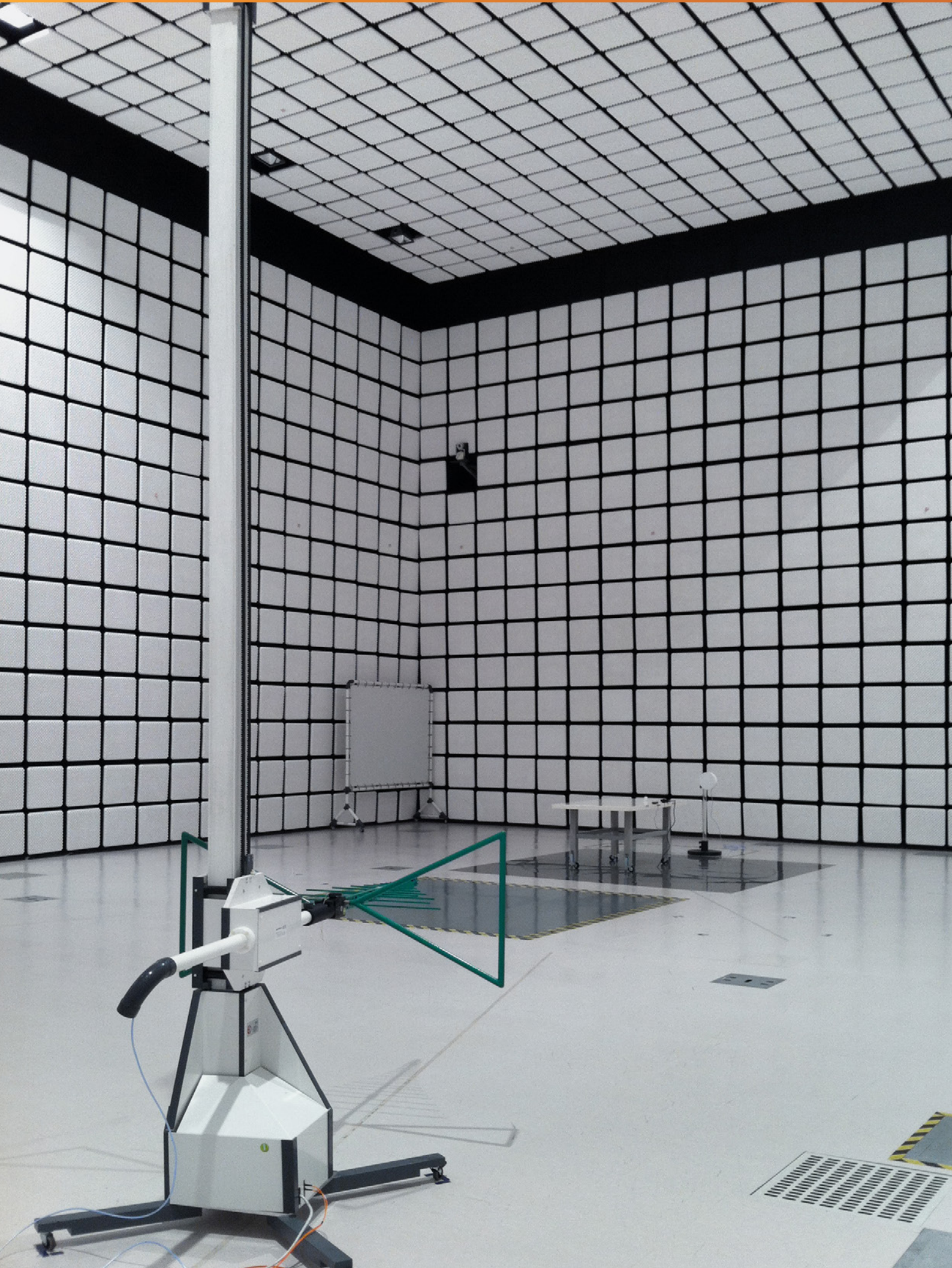



## | 13 | PROJECTION SCREENS

innco systems projection screens are designed to show the analyzer display next to the DUT in EMC chambers by an installed beamer.

The high quality material of the screen is also used in cinemas and provides best picture quality and less reflections.

The screens are available in two configurations: free standing (movable) or installed on the absorbers.

The screen ratio can be selected between 4:3, 16:9 or customized.



## | 13.1 | PRODUCT OVERVIEW

### FREE STANDING

- 100" screen diagonal
- 4:3 screen ratio
- Movable by rollers



### FOR ABSORBER INSTALLATION

- 100" & 112" screen diagonal
- 4:3 or 16:9 screen ratio
- Frameless mounting on invisible frame

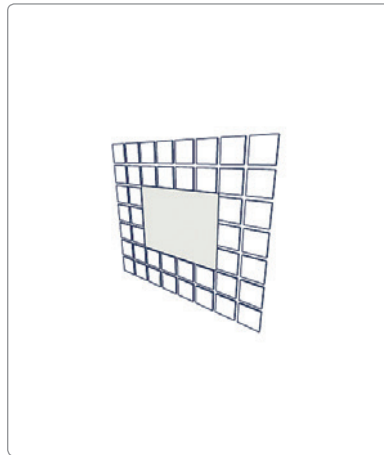



## | 13.2 | FREE STANDING

The PL100 beamer screen is designed as movable free standing screen for the using in EMC chambers. Sharp edges are minimised.

The fiber glass frame gives a stable appearance and is easy to mount.

### PROJECTION SCREEN FREE STANDING

Type	Description	Article No.
PL100-F	100" screen diagonal, ratio 4:3	80000472

### ACCESSORIES

Description	Article No.
Different screen size or ratio	On request

### SCOPE OF DELIVERY

Type	Quantity
Screen foil	1 x
Free standing mounting frame	1 x
Elastic cord	1 set
Operating manual	1 x

TECHNICAL DATA		
TYPE	PL110-F	
Screen diagonal	100" (2540 mm)	
Screen width	2030 mm	
Screen height	1502 mm	
Ratio	4:3	
Total height	approx. 2530 mm	
Total width	approx. 2550 mm	
Depth	700 mm	
Weight	approx. 30 kg	
Material	screen	PVC
	frame	fiber glass
	screen fixing + stretching	elastic cords with plastic hook
	rollers	plastic rollers with locker



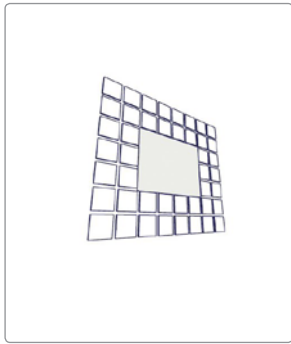

## | 13.3 | FOR ABSORBER INSTALLATION

The frameless PL beamer screen is designed to be fixed on the whitecaps of chamber absorbers.

The used screen foil "Flex White" is used for HD beamer screens and ensures a brilliant picture without reflections.

### PROJECTION SCREEN FOR ABSORBER INSTALLATION

Type	Description	Article No.
PL112 (16:9)	112" screen diagonal, ratio 16:9	80007084
PL100 (4:3)	100" screen diagonal, ratio 4:3	80000471

### SCOPE OF DELIVERY

Type	Quantity
Screen foil	1 x
Mounting frame	1 x
Plastic anchor plug	1 set
Operating manual	1 x

TECHNICAL DATA		
TYPE	PL112 (16:9)	PL100 (4:3)
Screen diagonal	112" (2865 mm)	110" (2540 mm)
Screen width	2500 mm	2030 mm
Screen height	1400 mm	1520 mm
Ratio	16:9	4:3
Total height	2500 mm	2030 mm
Total width	1400 mm	1520 mm
Depth	30 mm	
Weight	approx. 18 kg	approx. 16 kg
Material	screen	Flex White CI
	frame	Kömadur®







## | 14 | REACTION TIME TEST DEVICE

The Reaction Testing Device RTG-IV is a microcomputer time measuring device that works with a very high level of precision. The device has a randomiser that ensures a surprise effect during the testing process. The random time range is between 2 and 8 seconds. It measures the time between when the red signal lamp lights up (possibly with a signal sound) and when the subject presses the brake pedal. The microcomputer then uses the set speed and road condition to calculate:

- The reaction time
- The braking distance
- The stopping distance

The speed and road condition are displayed along with the reaction time. The set values and the test results are printed on a paper strip using an inbuilt printing device.

Eight speed levels can be set, whereby a test for reaction time only must be carried out with the setting “0 km/h”. The icons “Sun”, “Cloud”, “Ice” can set various road conditions.

As well as the speed and the road condition, there is also a brake response time and a brake effect time included in the calculation for the braking distance.

Furthermore, the output of the test result on the printout is made dependent on the selected test parameters.

## REACTION TIME TEST DEVICE

Type	Description	Article No.
RTG-IV	RTG: Reaction Test Device, with integrated printer, for 12 V & 230 V power supply	80000346

## ACCESSORIES

Description	Article No.
Pedal set for RTG IV	80004885
Paper roll (113 mm) for RTG IV	80500056

## SCOPE OF DELIVERY

Type	Quantity
Test device installed in aluminium case	1 x
Integrated printer	1 x
Pedal set	1 x
Spare paper roll	2 x
230 V power supply cable	1 x
12 V power supply cable (with vehicle-plug)	1 x
Operating manual	1 x

## TECHNICAL DATA

TYPE	RTG-IV
Adjustable speed range	0, 30, 50, 80, 100, 130, 150 & 200 km/h
Adjustable road condition	dry, wet, ice
Integrated thermal printer	112 mm paper, 25m – approx. 230 prints
Operating voltage	12 V DC (with vehicle plug), 230 V AC 50 / 60 Hz
Dimensions	45 x 34 x 16 / 44 cm (width x depth x height closed / open)
Fuse	T 125 mA / 250 V
Weight	approx. 8 kg
Temperature range	+8 °C...+40 °C



## COMMON ABBREVIATIONS

CP	Center / connector panel
FSMA	FSMA connector (field installable subminiature assembly)
FO cable	Fiber optic cable
POF	Polymer optical fiber
GOF	Glass optical fiber
g	Gram
kg	Kilogramm
t	Metric tons
m	Meter
mm	Millimeter
OATS	Open Area Test Side
rpm	Round per minute
km/h	Kilometers per hour
°/s	Degree per second
RPS	Dynamometer

## SPECIFIC ABBREVIATIONS BY INNCO SYSTEMS

-1D	1 Device
-3rpm	Maximal speed up to 3 rpm
-4p	4 ports
-8p	8 ports
-7/16	Polarisation rod with bigger inner diameter for 7/16" connector
-CF	Cooling fan for airstream
-CISPR16	Antenna rod extend to 2000 mm
-CW	Counter weight
-D	Dismountable for transport & storage
-DG	Degreewise polarisation
-DT	Integrated for turntables
-E	Embedded for chamber floors
-EC	Energy hain (no cable installation)
-EG	Exhaust gas system on the turntable

-EP	Electric polarisation
-CP	Contionous polarisation
-ER	Endless turning (permanent positioning)
-ET	Electric tilt
-F	Free standing
-H	Height adjustable
-HA	Wooden plate for freestanding installation
-HE	Wooden cover for installation in raised floor
-HK	Hand crank
-HL	Higher load
-HP	High precision positioning
-HP High	Precision positioning (0.1 angular degree)
-HS	Max. speed up to ... cm/s
-IR	Installed rollers (only movable in unloaded condition)
-IT-XX00	Integrated turntable (diameter)
-M	Manual positioning for VSWR (no drive unit)
-MP	Manual polarization
-MR	Mast section ratatable
-MT	Manual tilt
-MV	Movable version with wheels instead of stands
-O	OATS Version
-P	Pneumatic operation
-PP	Pneumatic polarisation
-PR	Polarisation rod
-PTP	Pertinax top plate
-RH	Rohacell®
-RPS	Preparation for dynamometer
-S	Stainless steel cover
-SD	Polystyrene
-SR	Sideways mounted ring
-SS	Limit switch system (Security Switch)
-ST	Sideways mounted tube
-t	Higher capacity for turntable DT-S series
-TPP	Twin pneumatic polarisation
-XP	Pneumatic polarisation by internal compressor
-XXkg	Other loads



## INNCO SYSTEMS GMBH



innco systems GmbH is a medium-sized company located in Schwarzenfeld (Germany).

We are one of the world's leading manufacturers of electromagnetic positioning systems for EMV / EMC measurement applications and in the area of HF measuring technology. Special orders according to customer requirements are just as much a part of our product spectrum as standard systems proven over many years.

Our active, direct work on site with customers means we are a competent contact point at any time as an independent supplier for positioning tasks. Short decision paths, customer-orientated suggestions for solutions, and the greatest possible flexibility guarantee high-quality products to give our customers that added value they need to be competitive – globally.

### Origin

innco systems GmbH was founded in 2008 from a merger of HD-GmbH and Inn-Co GmbH and is therefore the direct successor of both. This ensures that former customers of those two companies also receive uninterrupted service and support for their systems as they need it – without limitation or legal concerns.





innco systems GmbH  
Erlenweg 12  
92521 Schwarzenfeld  
Germany

Phone +49(0)9435/301659-0  
Fax +49(0)9435/301659-99  
E-Mail [info@inncosystems.com](mailto:info@inncosystems.com)  
[www.inncosystems.com](http://www.inncosystems.com)

